



ПРИЛОЖЕНИЕ

к учебно-методическому
пособию для учителей
**«Факультативные занятия.
Математическая радуга.
1 класс»**

Для работы с приложением его необходимо снять со скобы
и разрезать на отдельные карточки и рисунки.

Приложение 1, занятие 1

Рисунок «Что вокруг?»

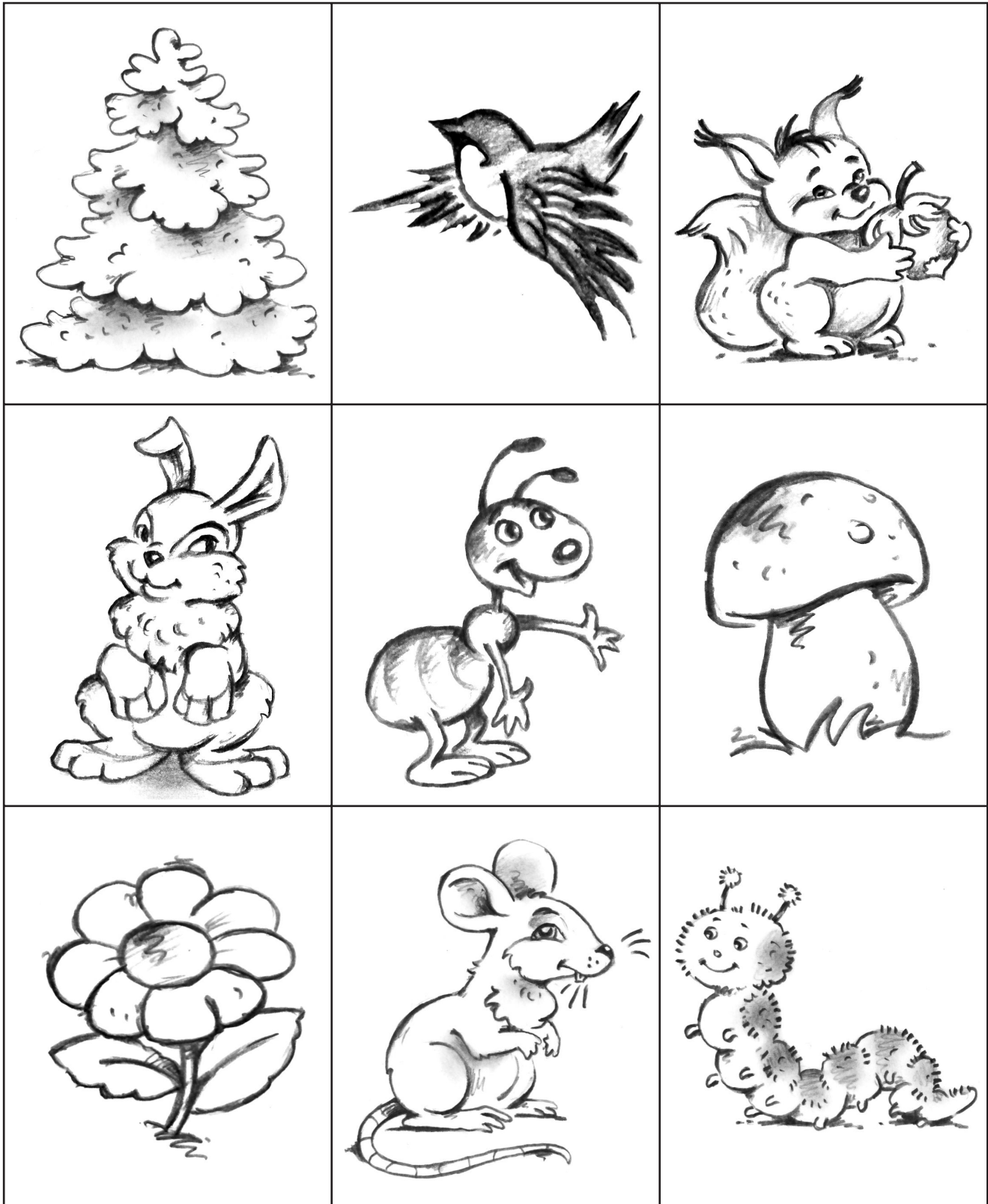

Приложение 3, занятие 2

Рисунок «Буратино»

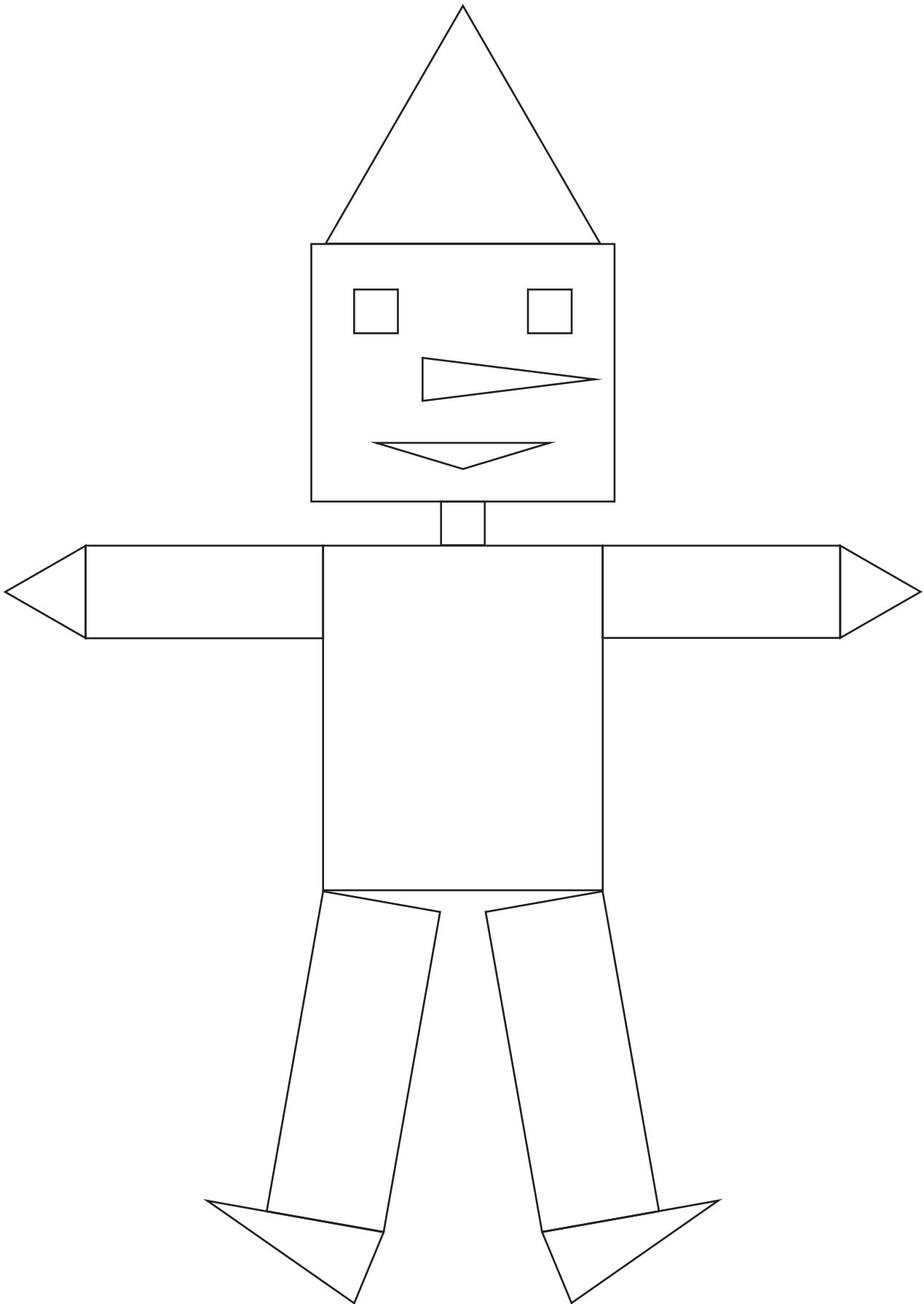

Приложение 4, занятие 4

Карточки «Сложи узор»

*Перед началом занятия необходимо раскрасить карточки согласно указанным цветам или сделать аппликацию из цветной бумаги.

с — синий, к — красный, ж — желтый, б — белый.

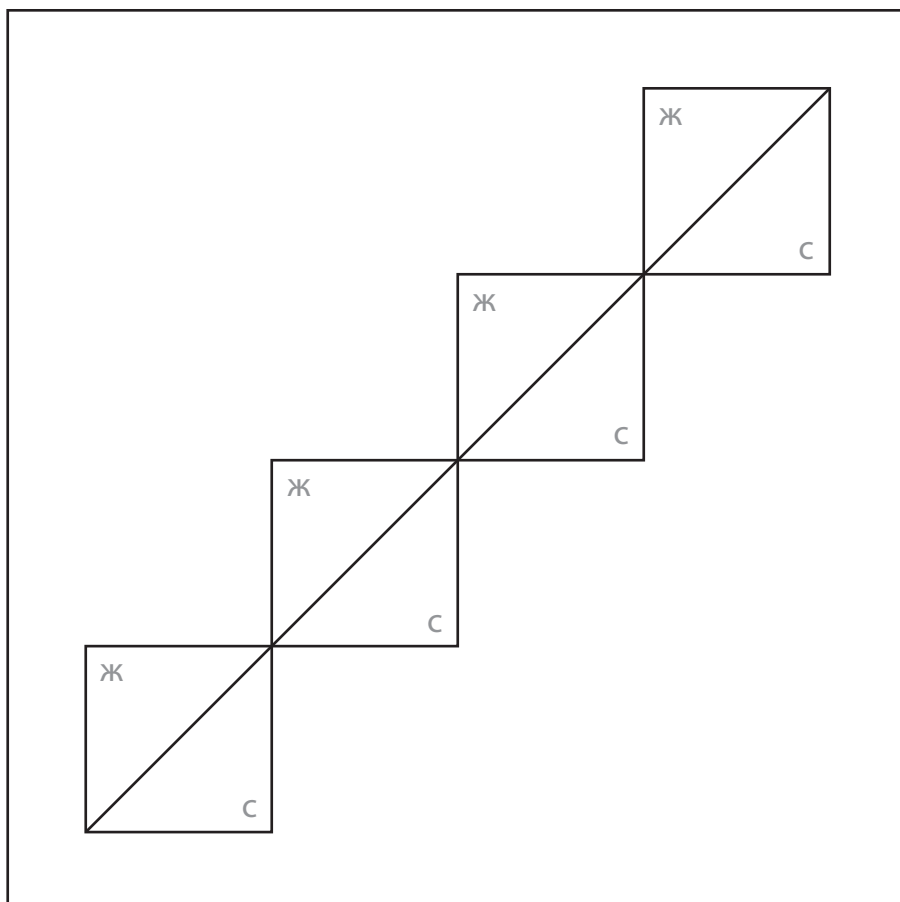
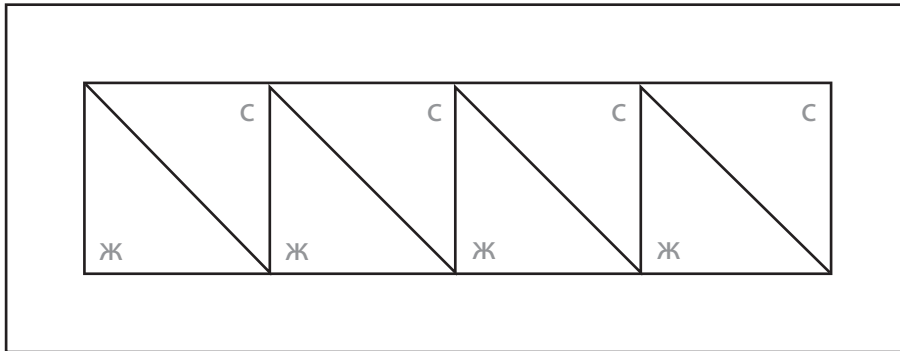

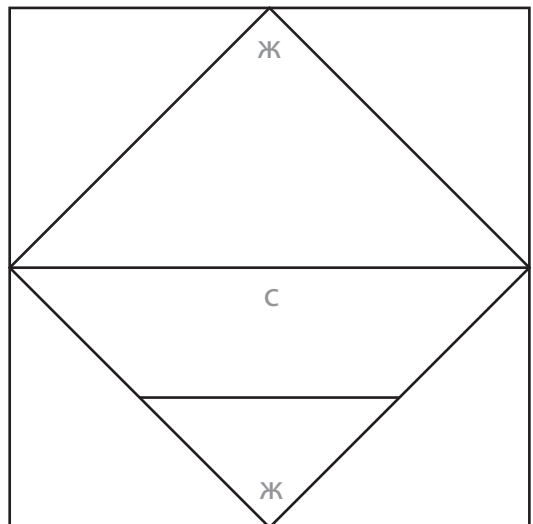
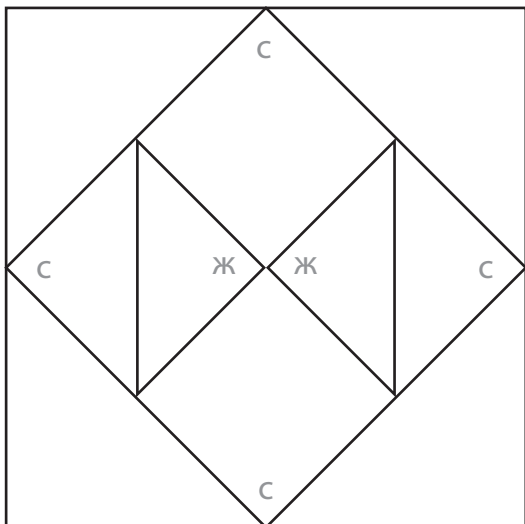
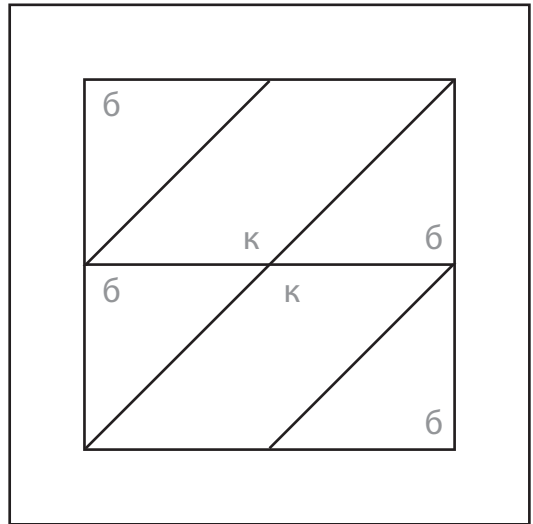
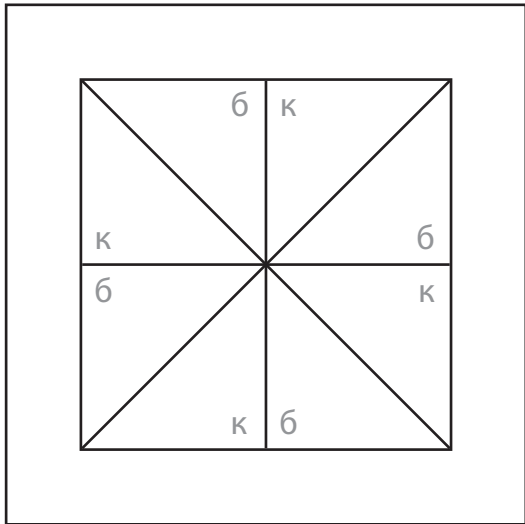
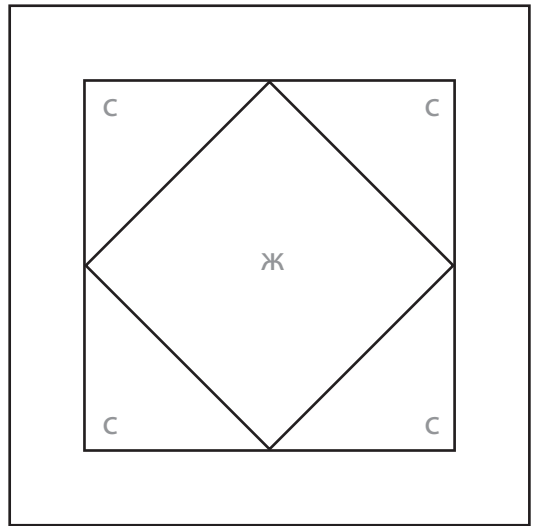
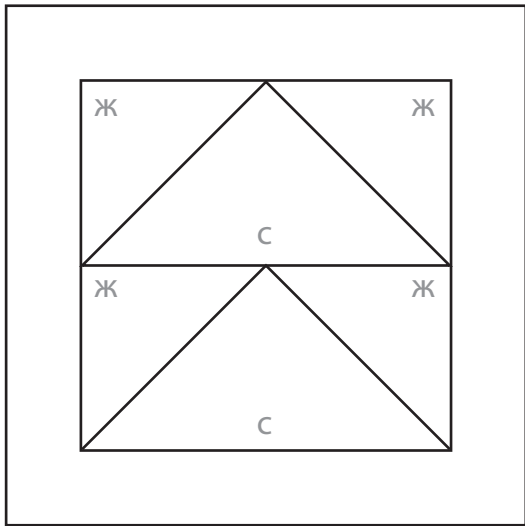

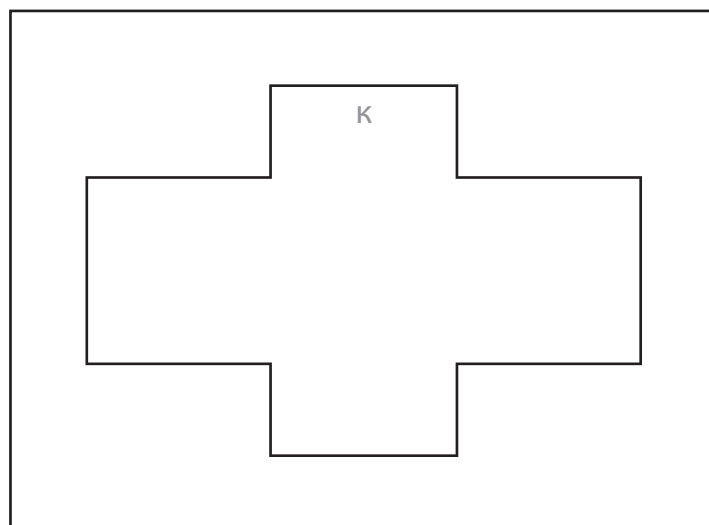
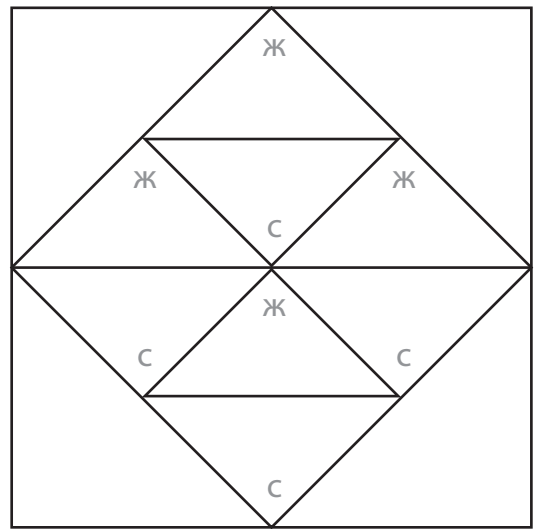
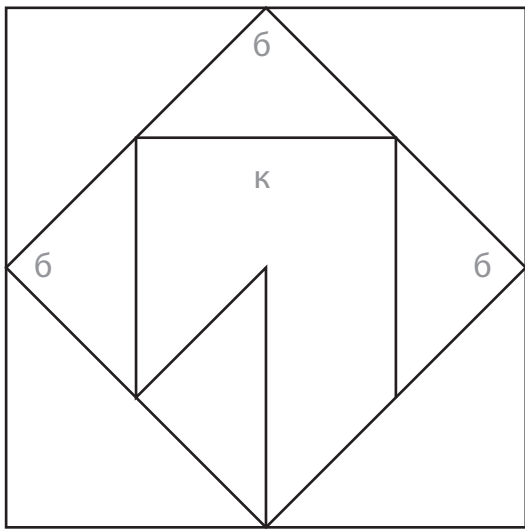
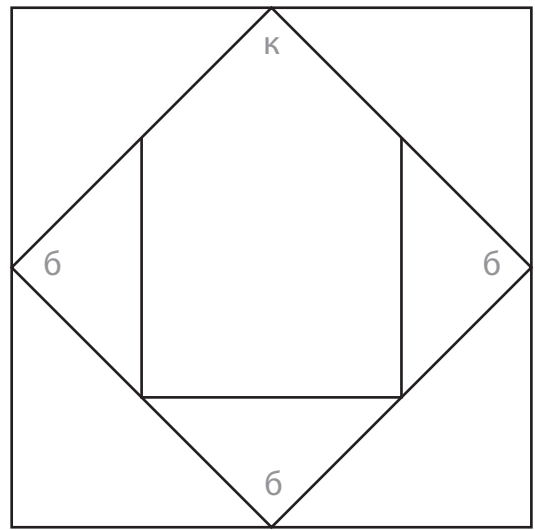
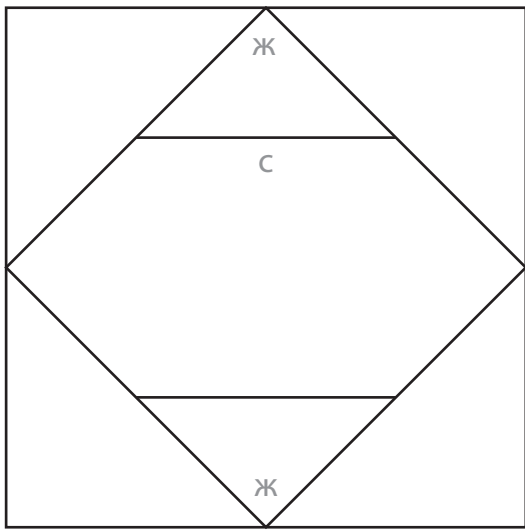

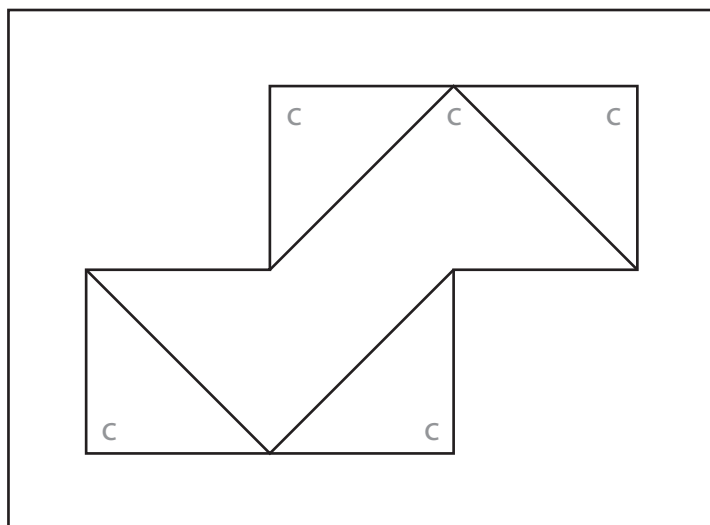
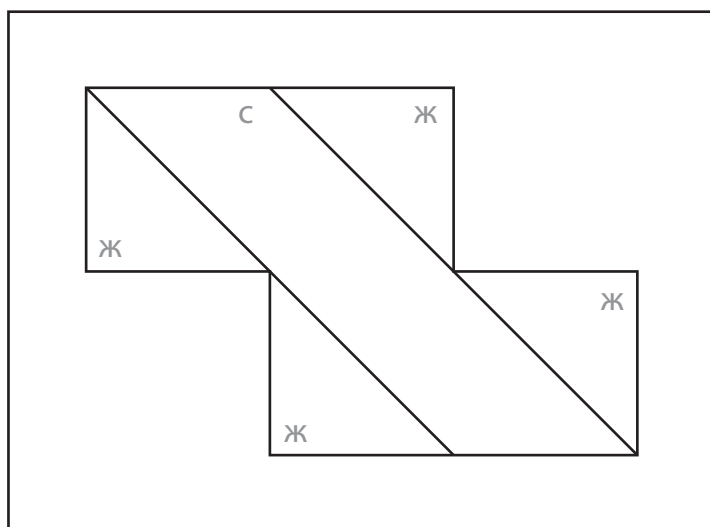
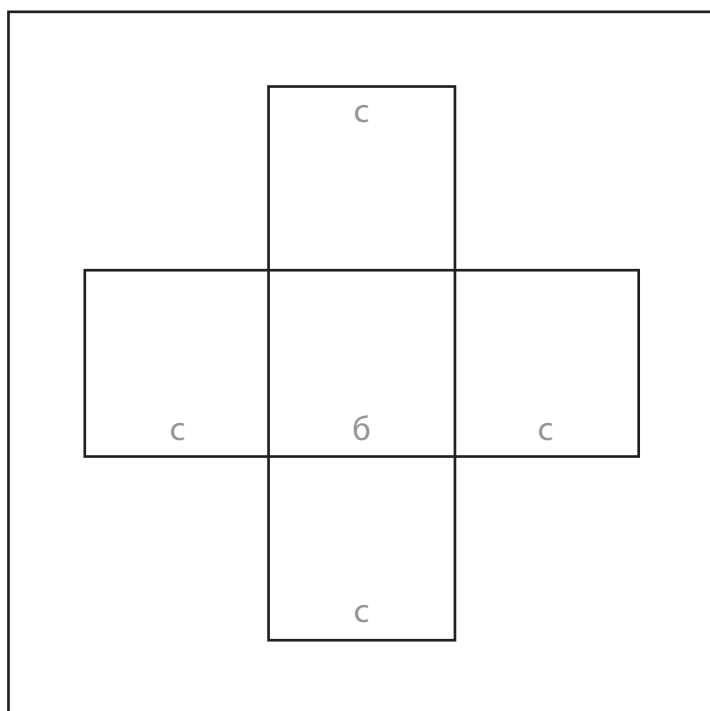

Приложение 5, занятие 6

Рисунок «Отгадай палочку»

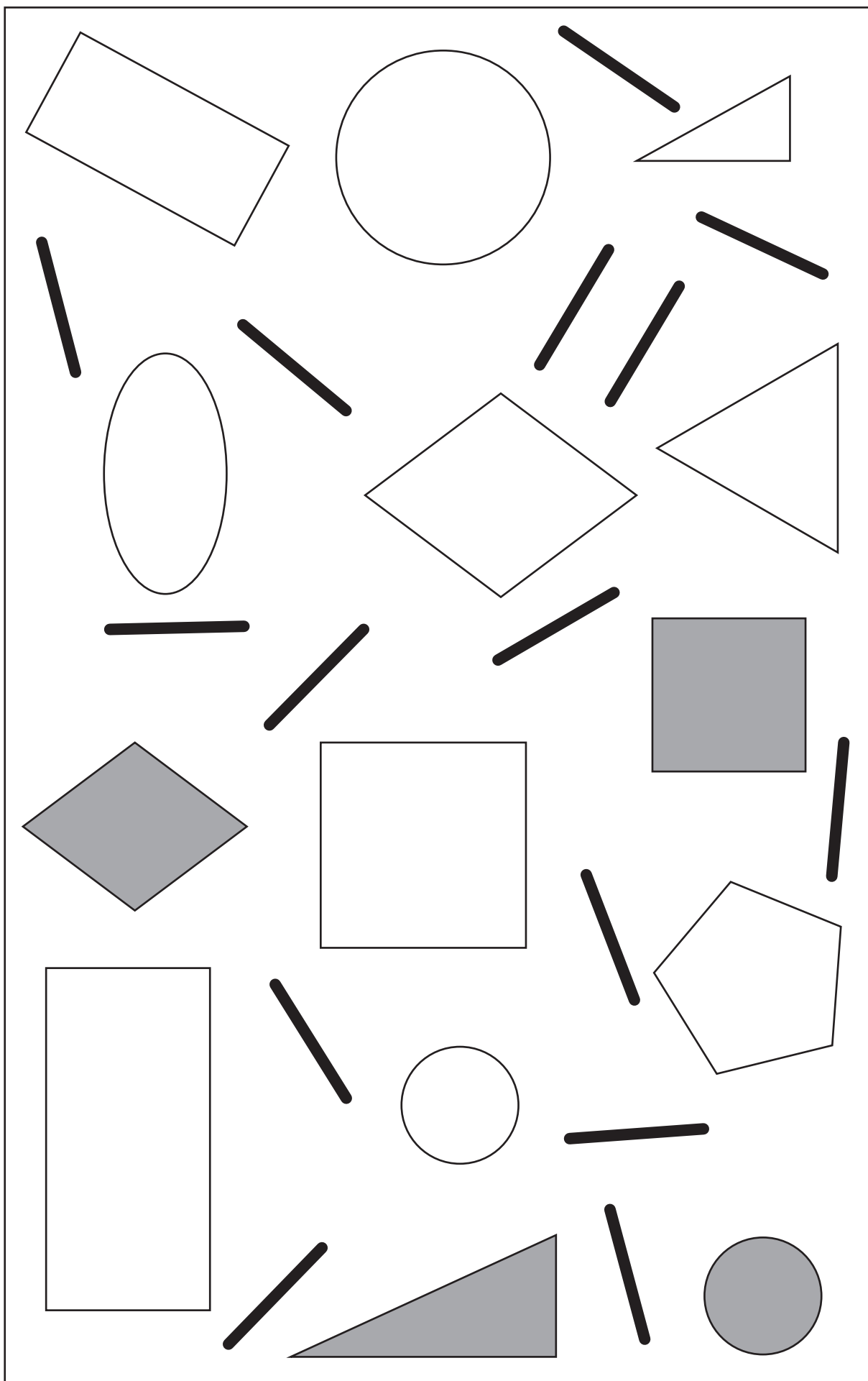

Приложение 6, занятие 6
Карточки «Куда смотрят игрушки?»

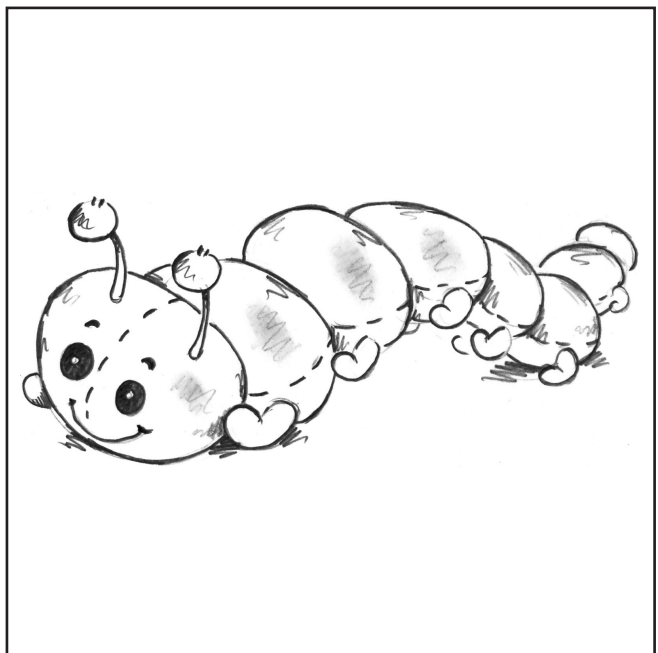
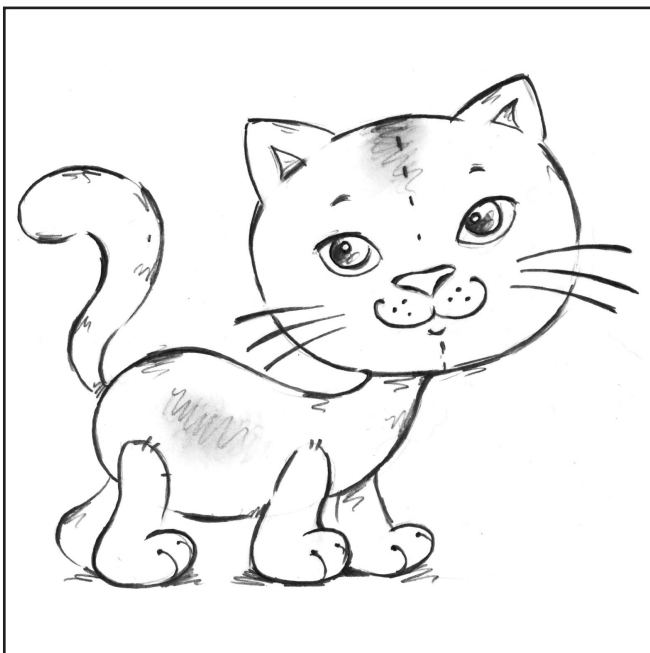
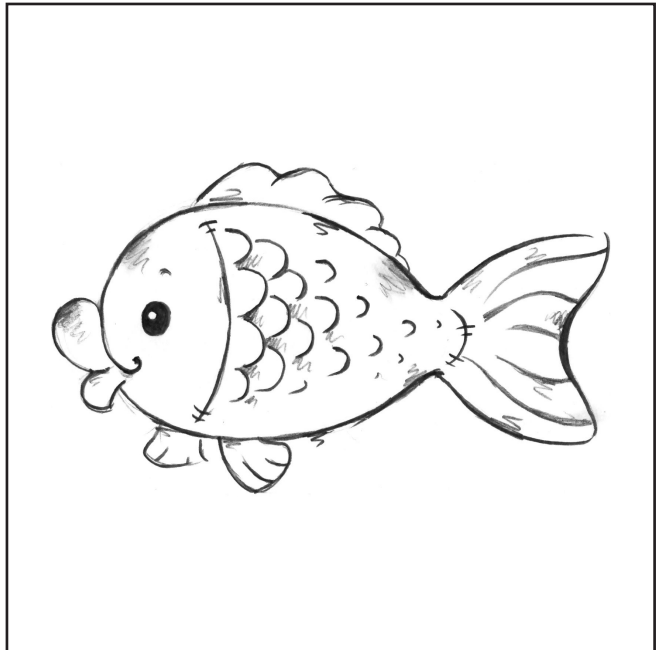
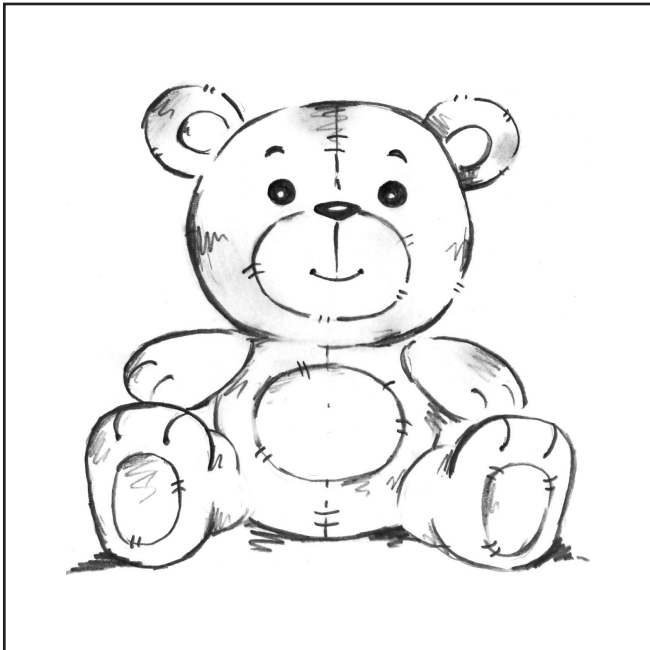

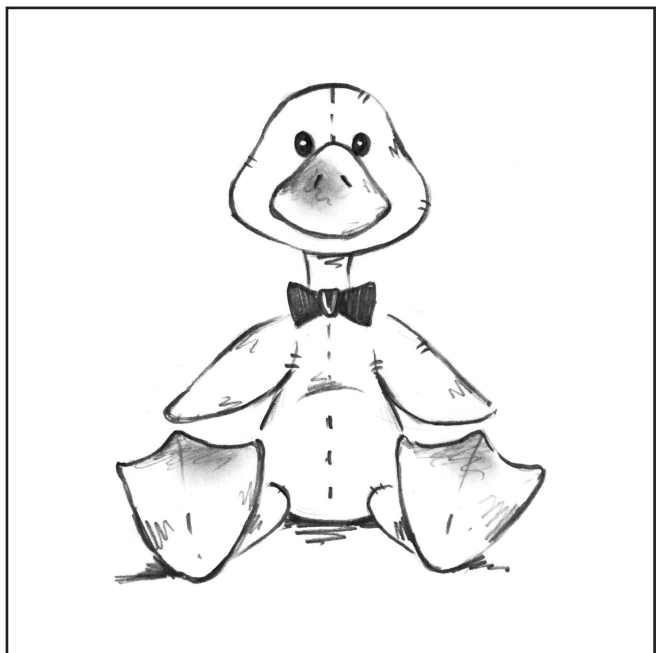
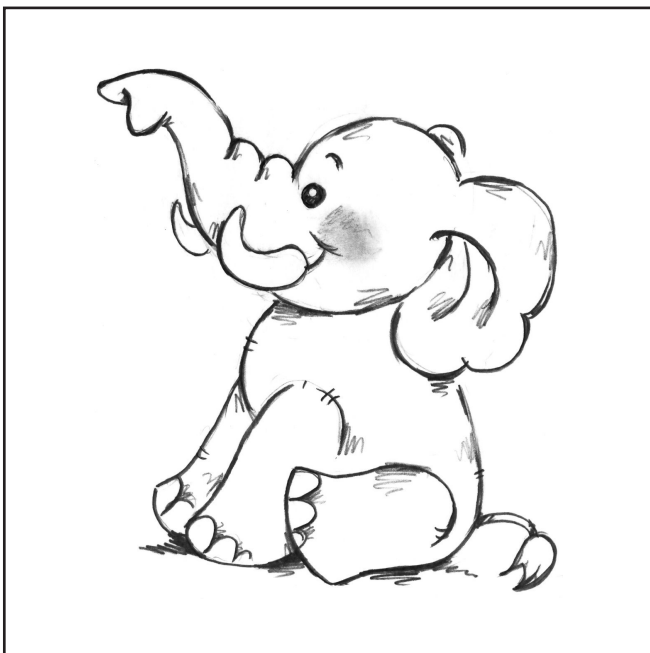
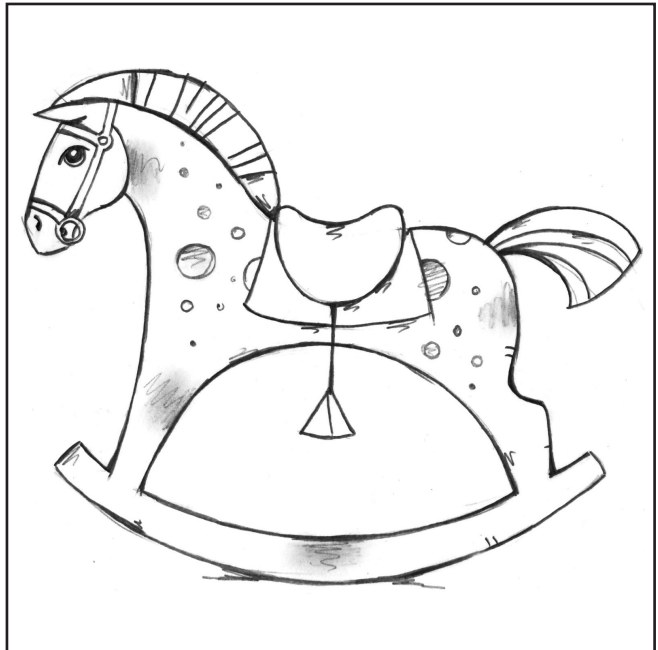

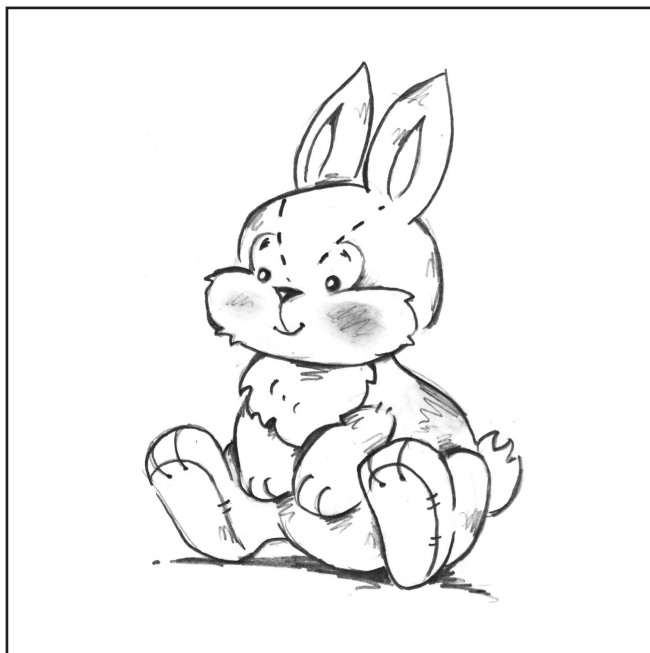
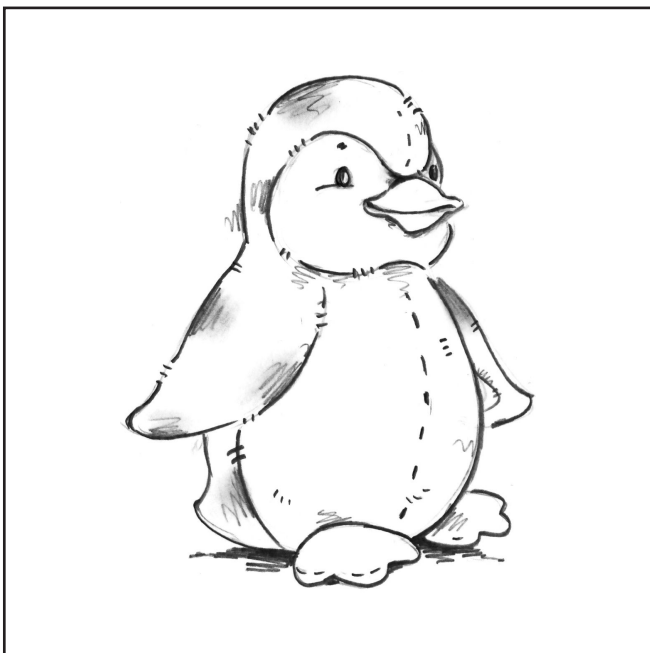
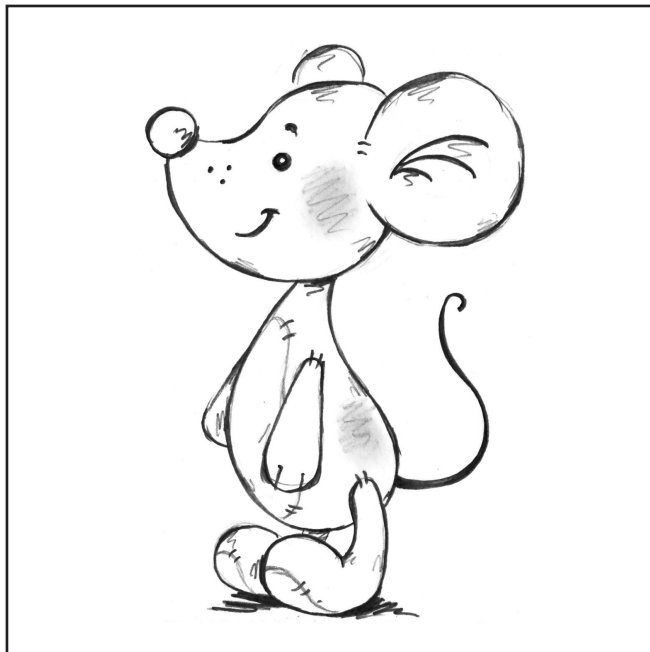
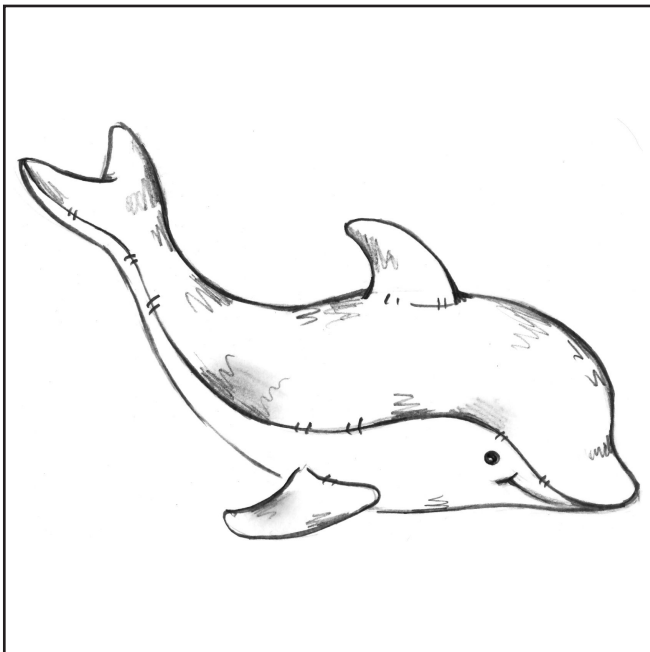

Приложение 8, занятие 7
Рисунок «Маршруты для Волка»

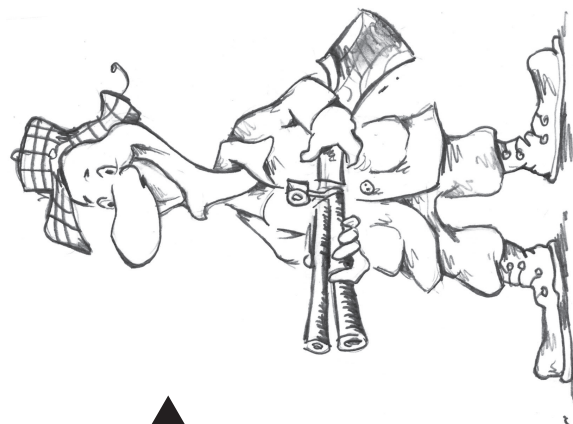
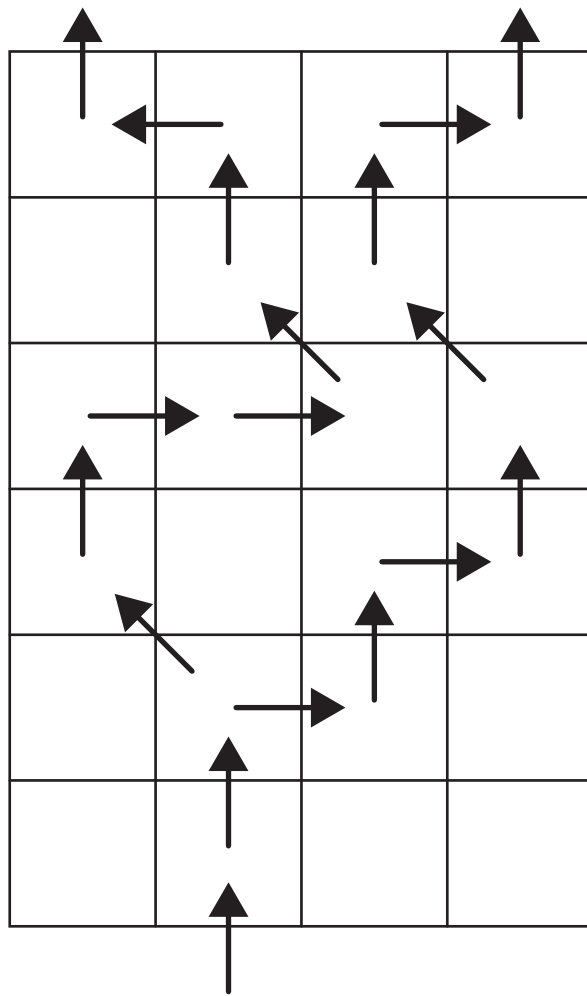
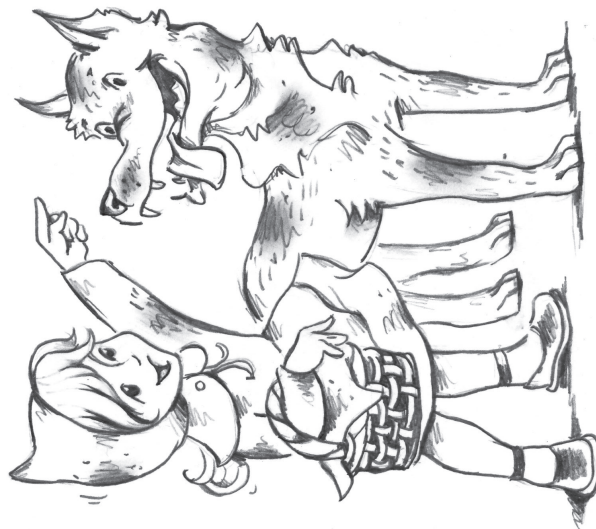

Приложение 11, занятие 8

Рисунок «Лента ответов»

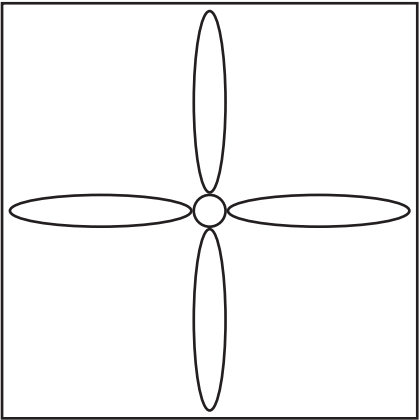
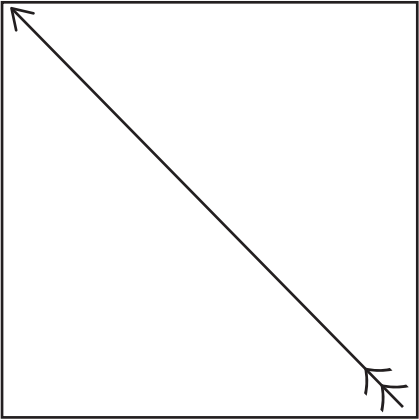
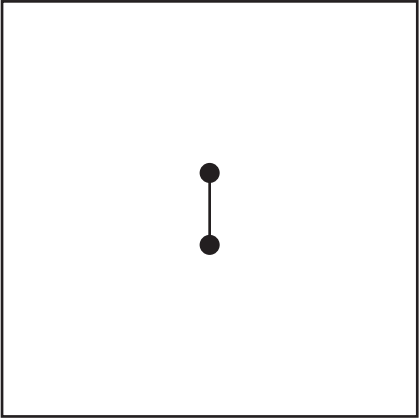
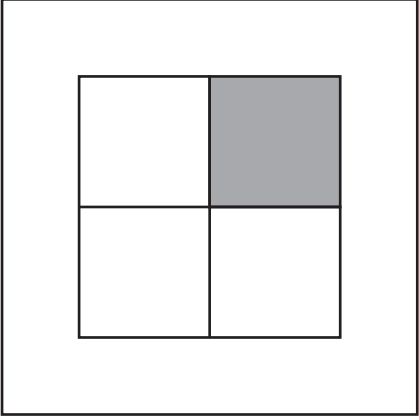
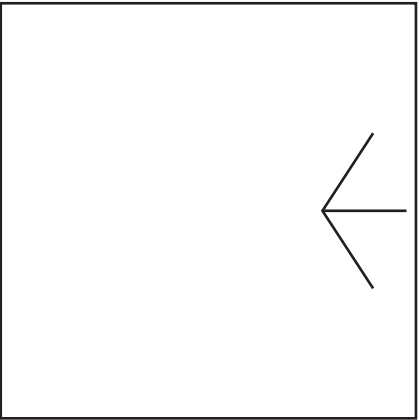
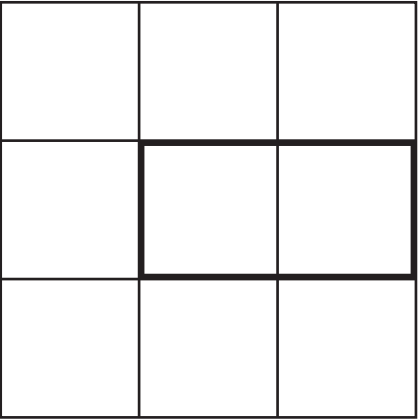
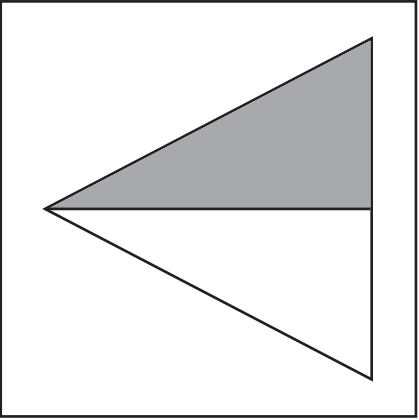
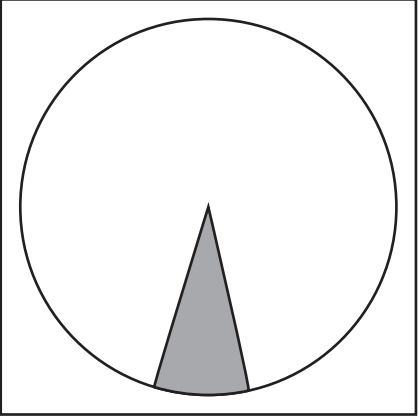
1)		2)		3)		4)	
5)		6)		7)		8)	

Приложение 14, занятие 11
Карточки «Контурсы цифр»

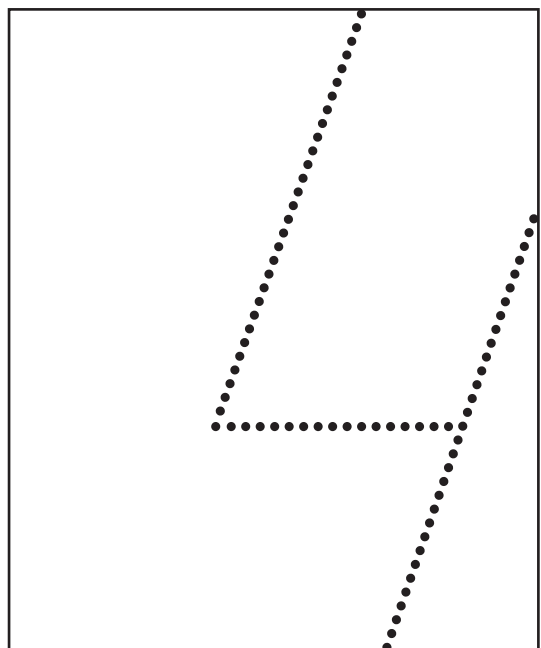
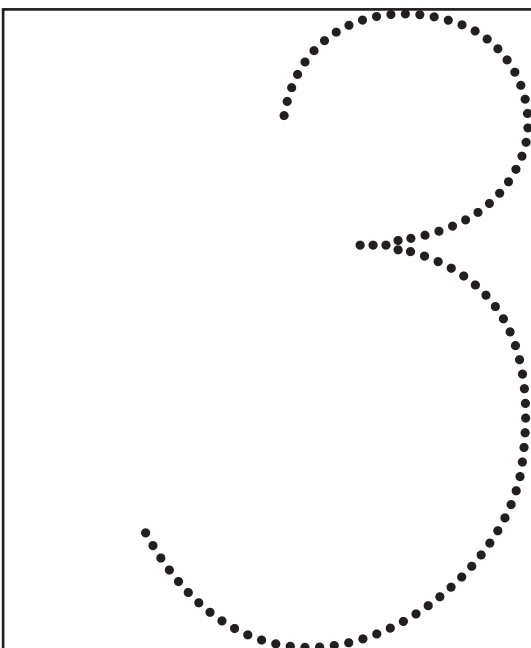
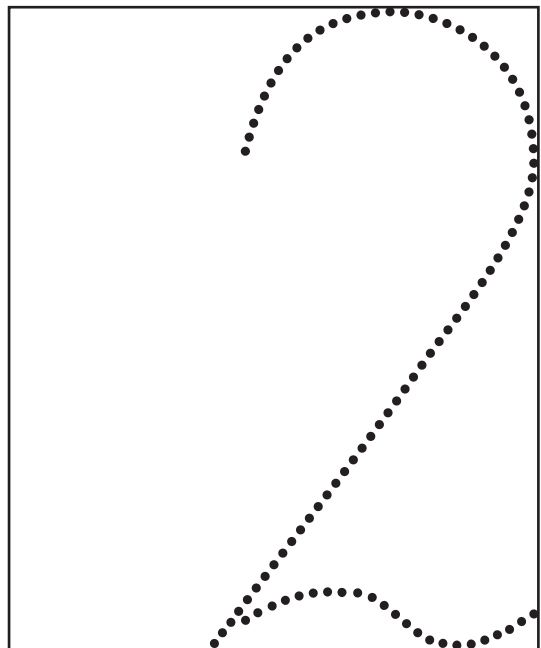
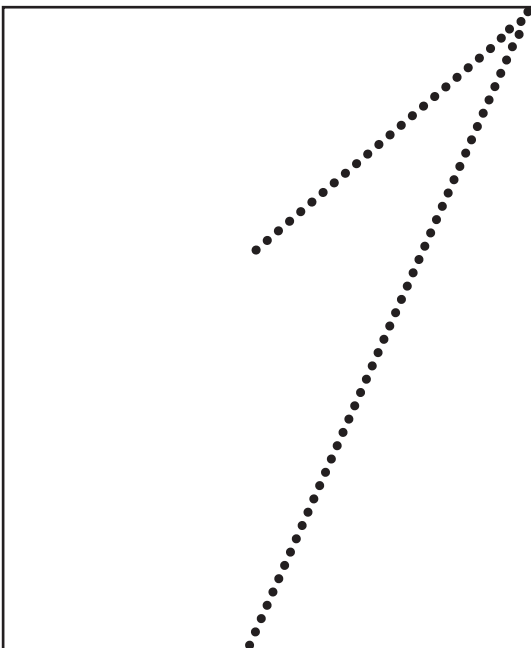
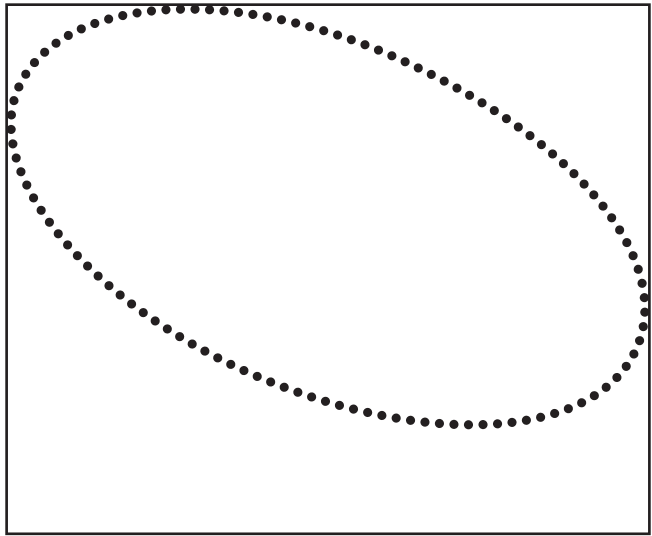

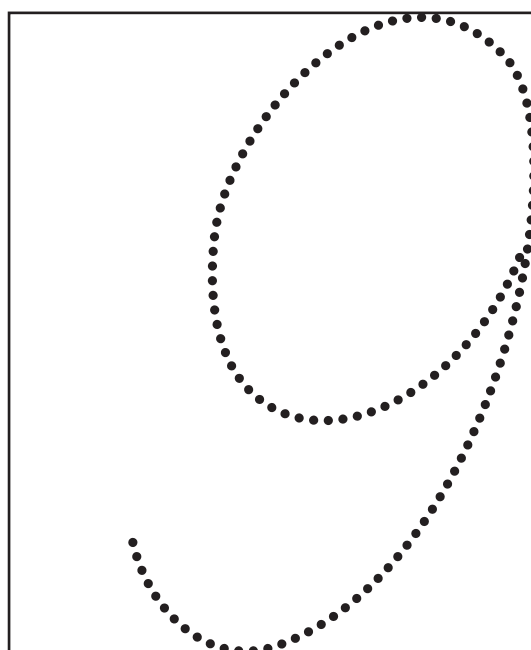
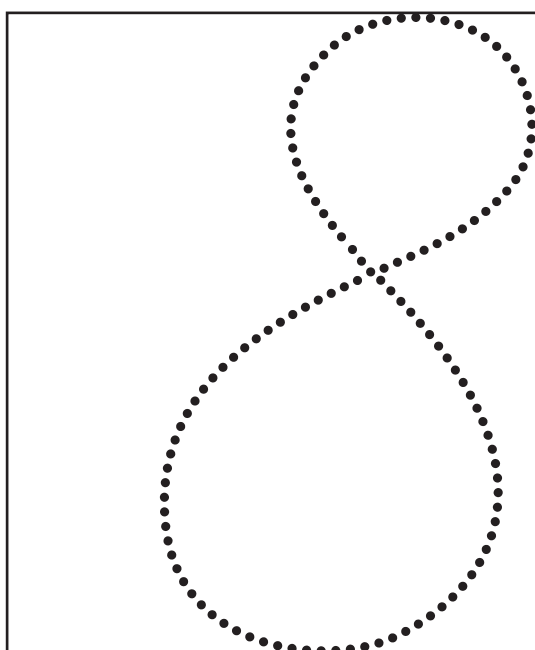
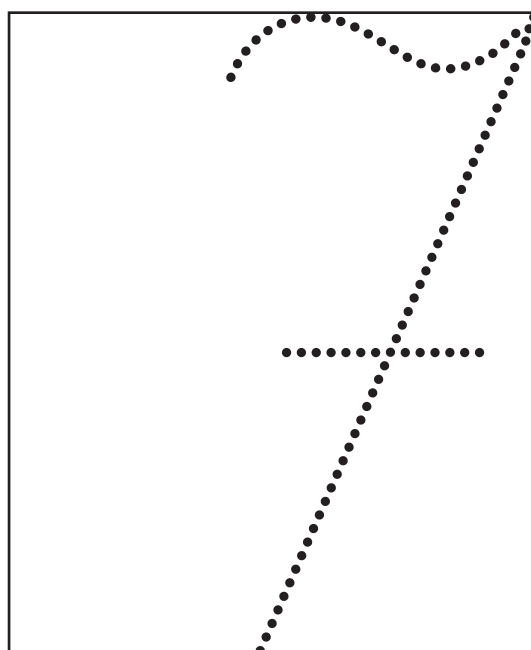
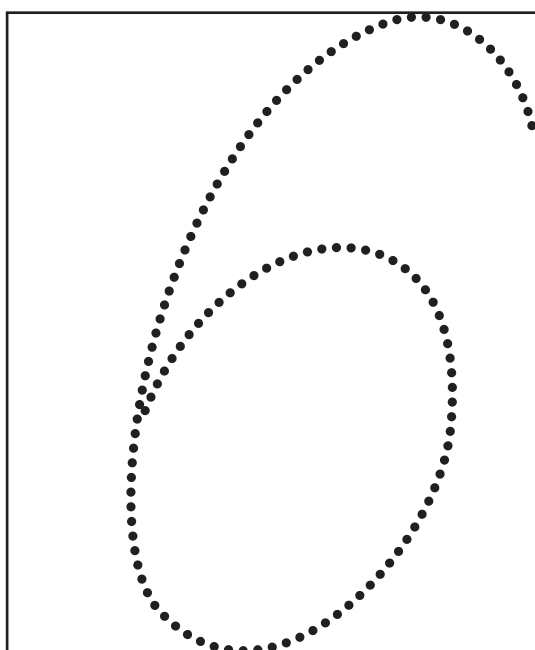
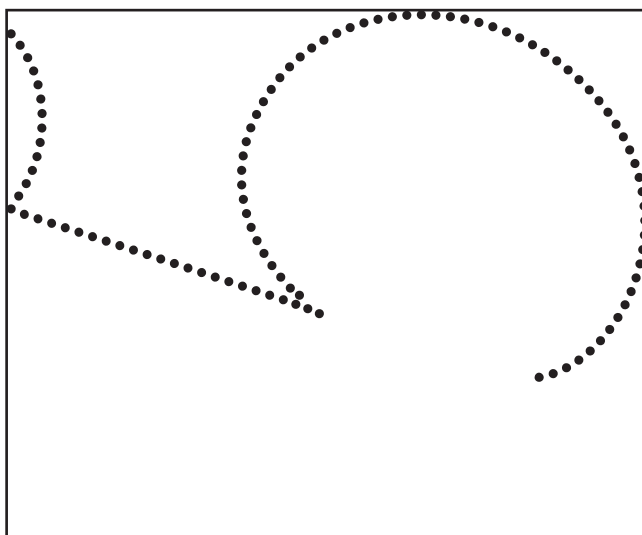

Приложение 18, занятие 14
Карточки «Птицы»

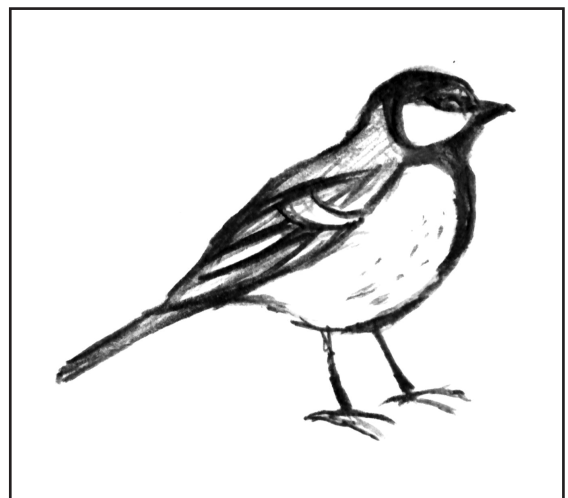
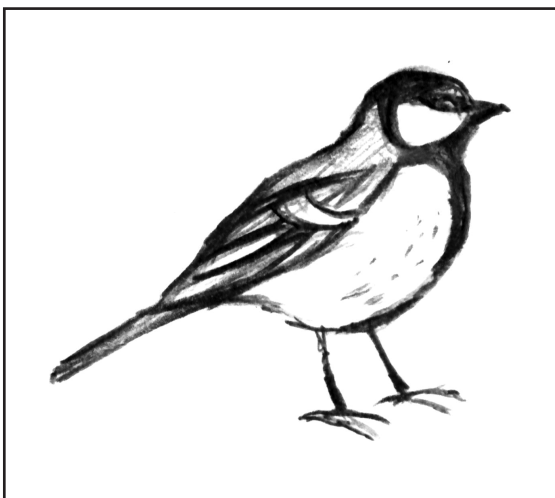
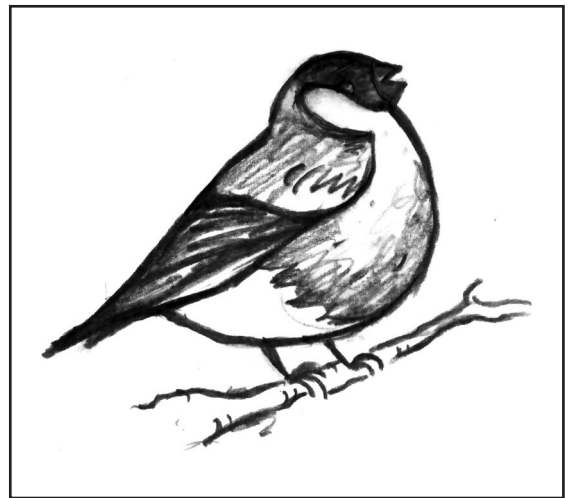
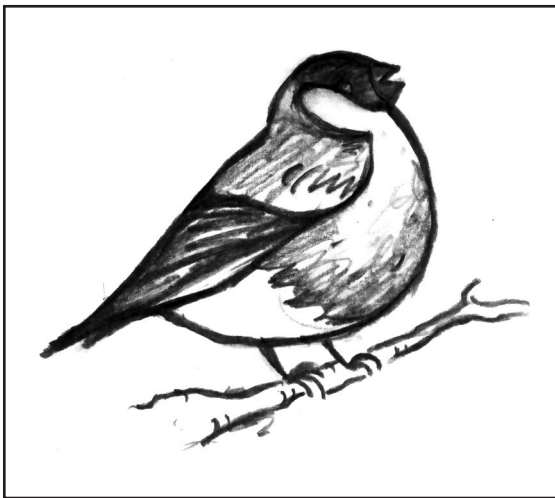
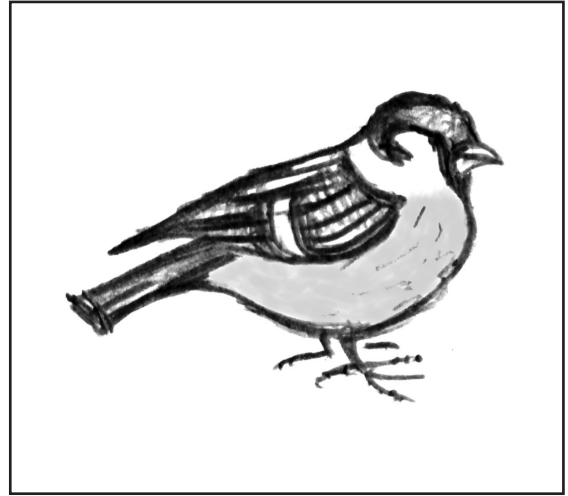
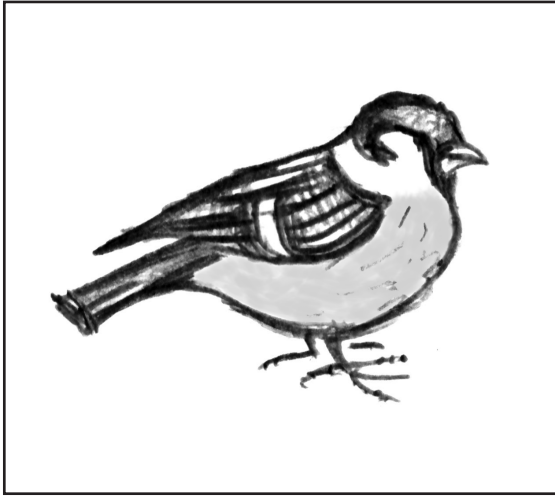

Приложение 2, занятие 1

Карточки «Ищем продолжение орнамента»

а)

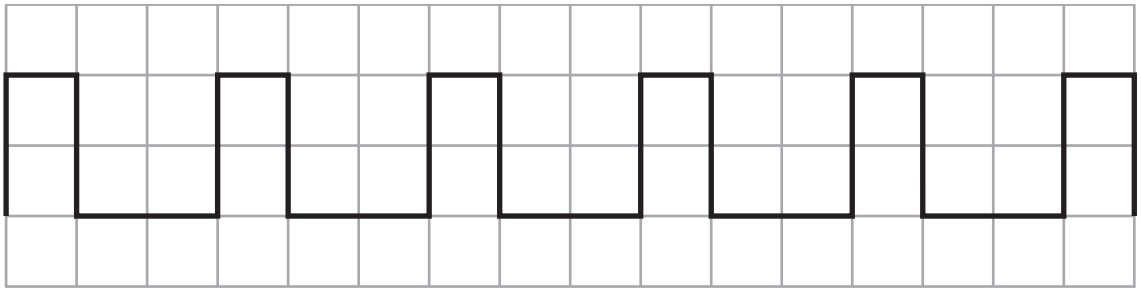

б)

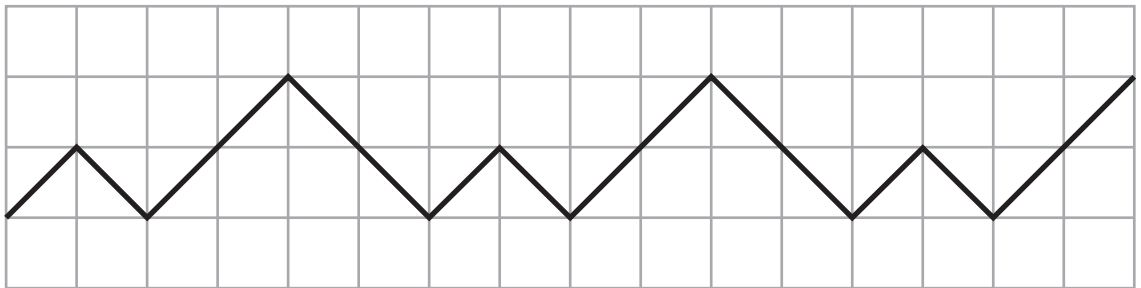

в)

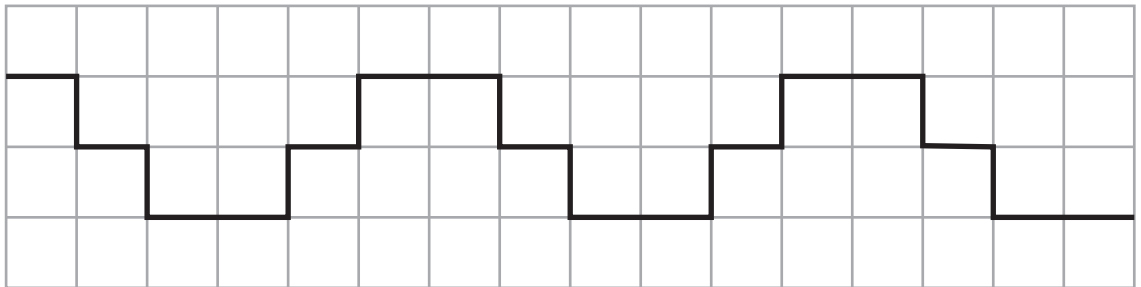

г)

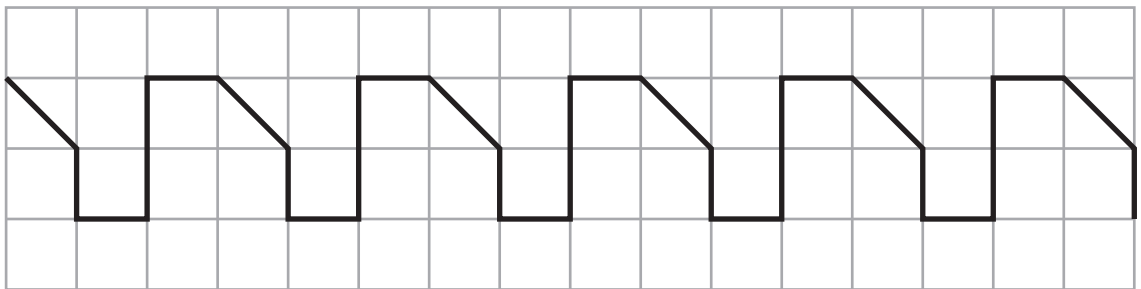

д)

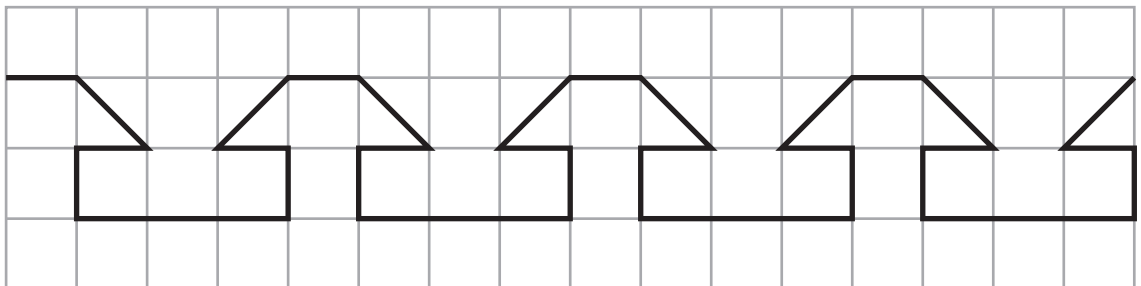

Приложение 7, занятие 6

Рисунок «Задачи с палочками»

- 1) Переложите две палочки так, чтобы рыбка нырнула.
- 2) Переложите одну палочку так, чтобы из одного дома получилось два.
- 3) Переложите две палочки так, чтобы елочка превратилась в рыбку.

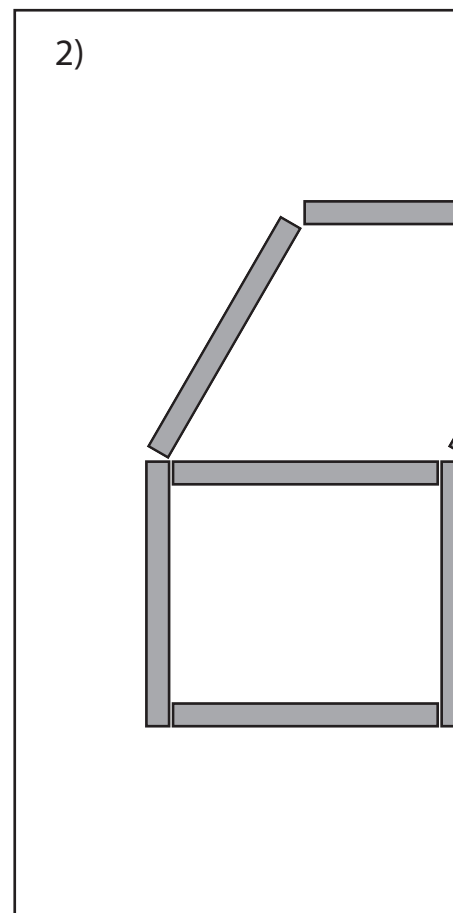
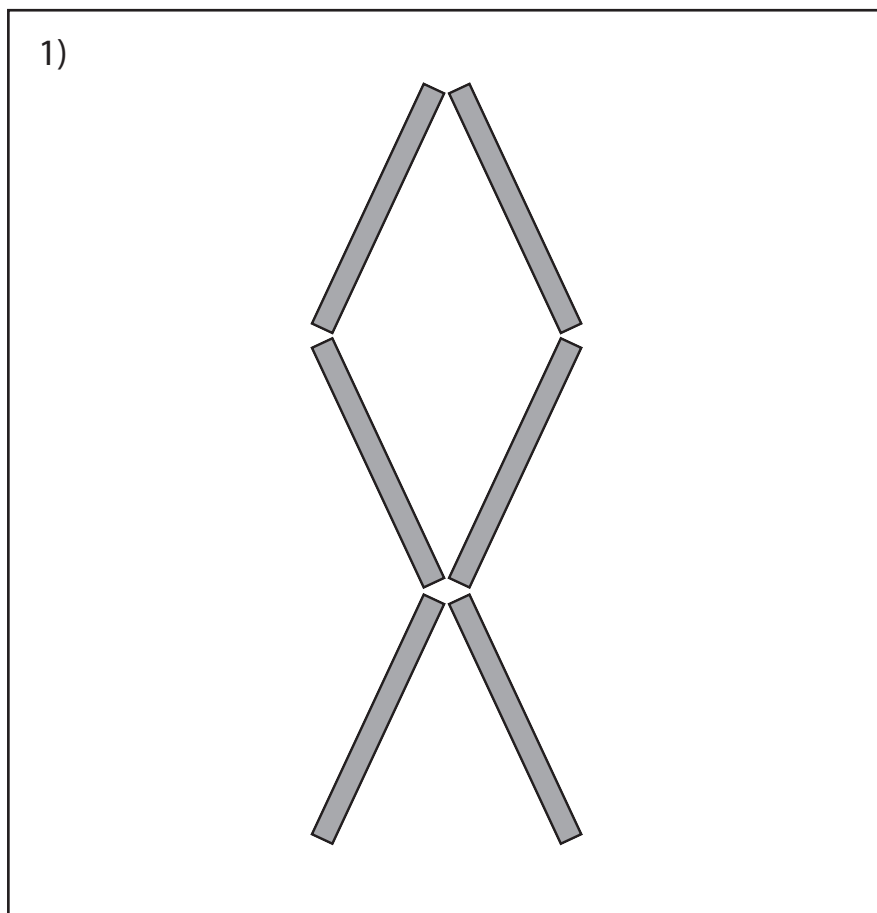

Приложение 9, занятие 8
Карточки «Узнавание фигур»

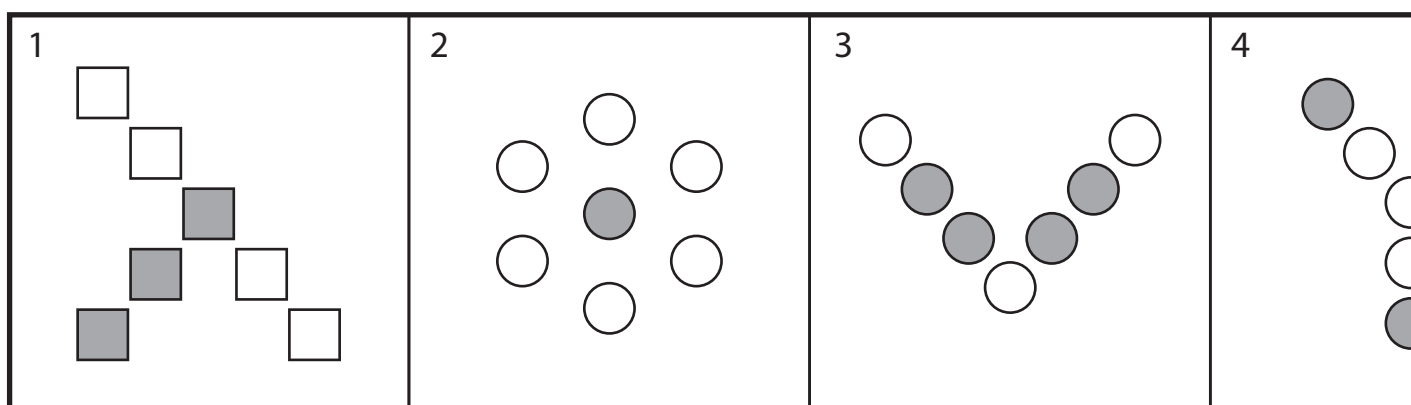
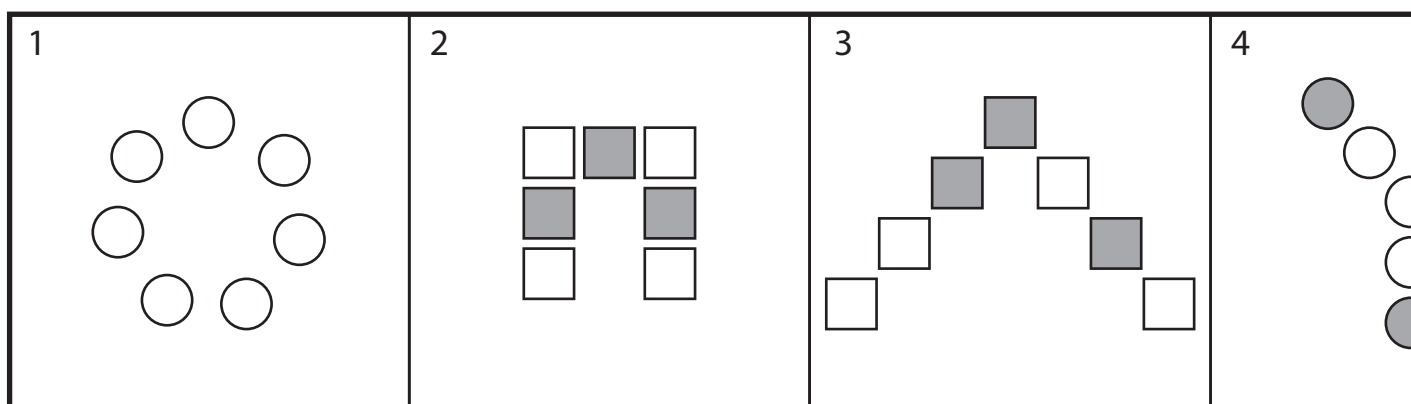
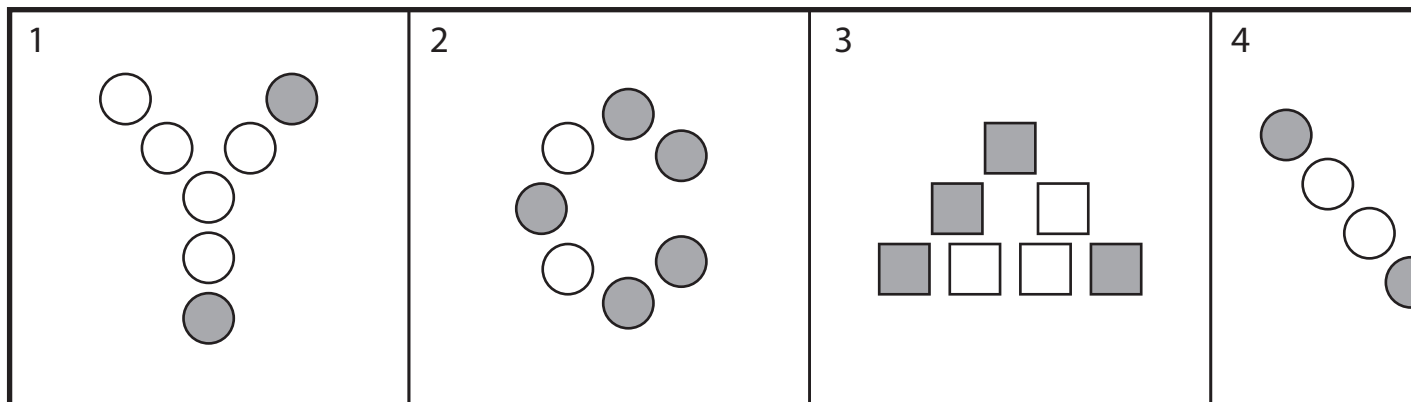

Приложение 10, занятие 8
Рисунок «Узнавание фигур»

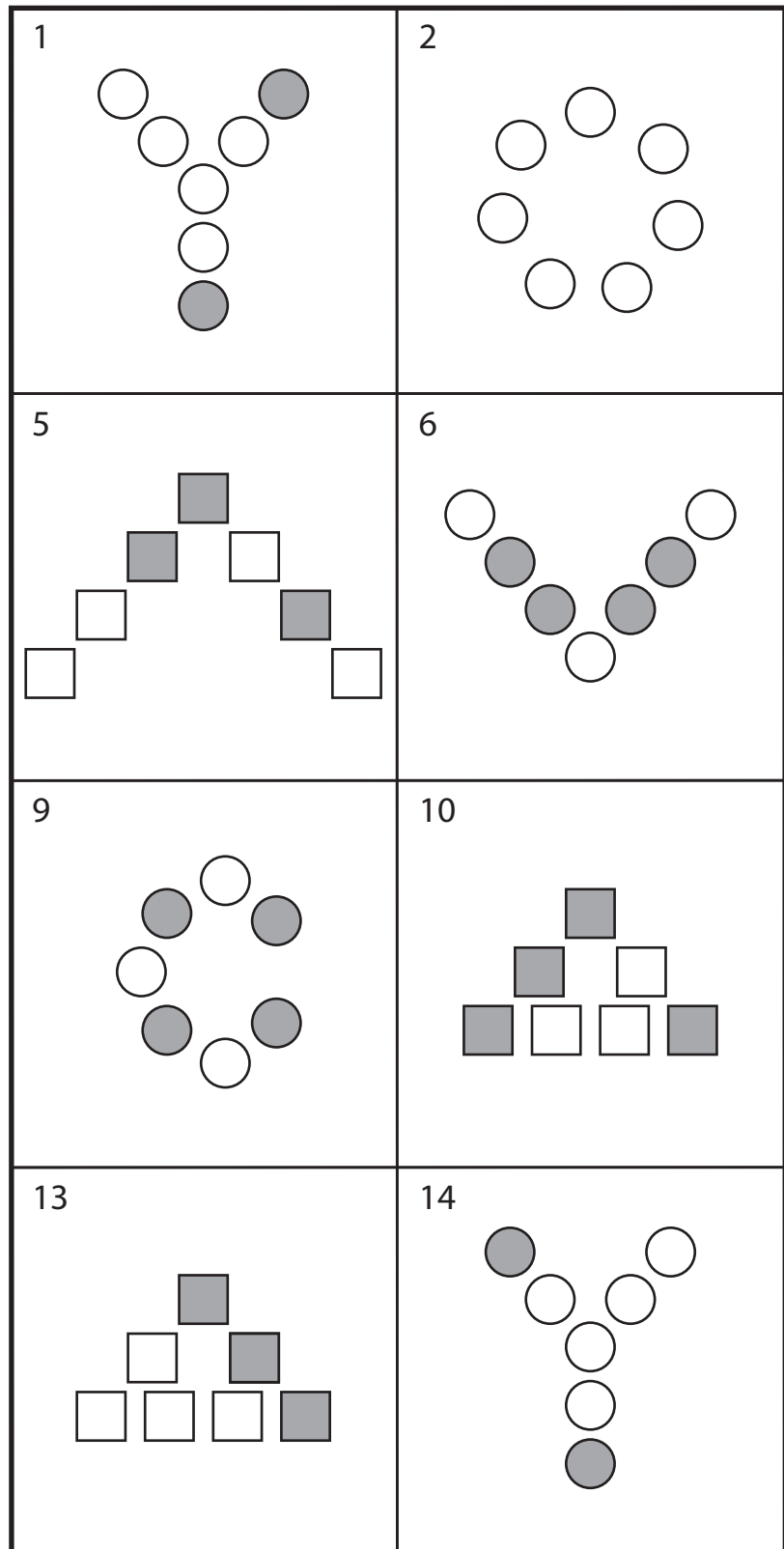

Приложение 12, занятие 9

Карточки «Два в одном»

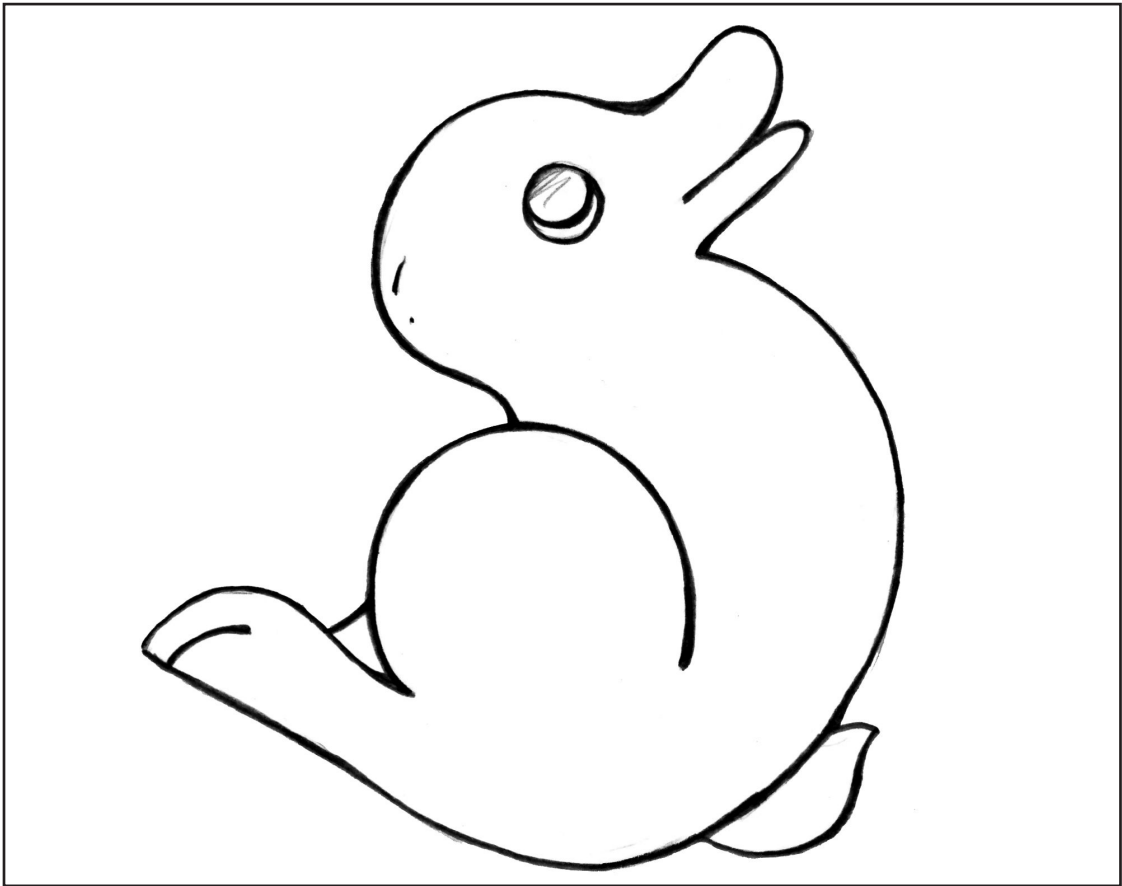

Приложение 13, занятие 11

Рисунок «Цифры»



Приложение 16, занятие 11

Карточки «На что похоже?»

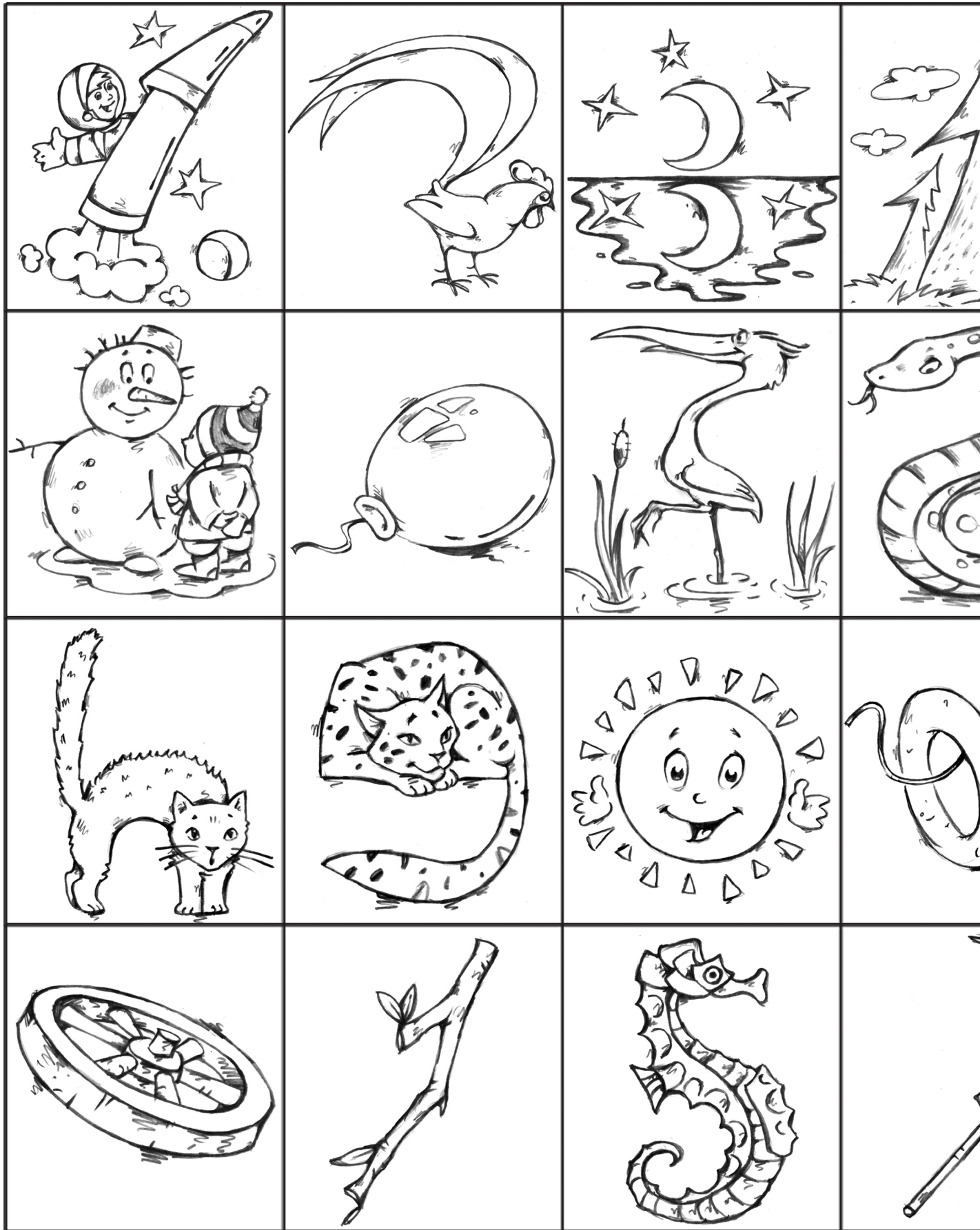





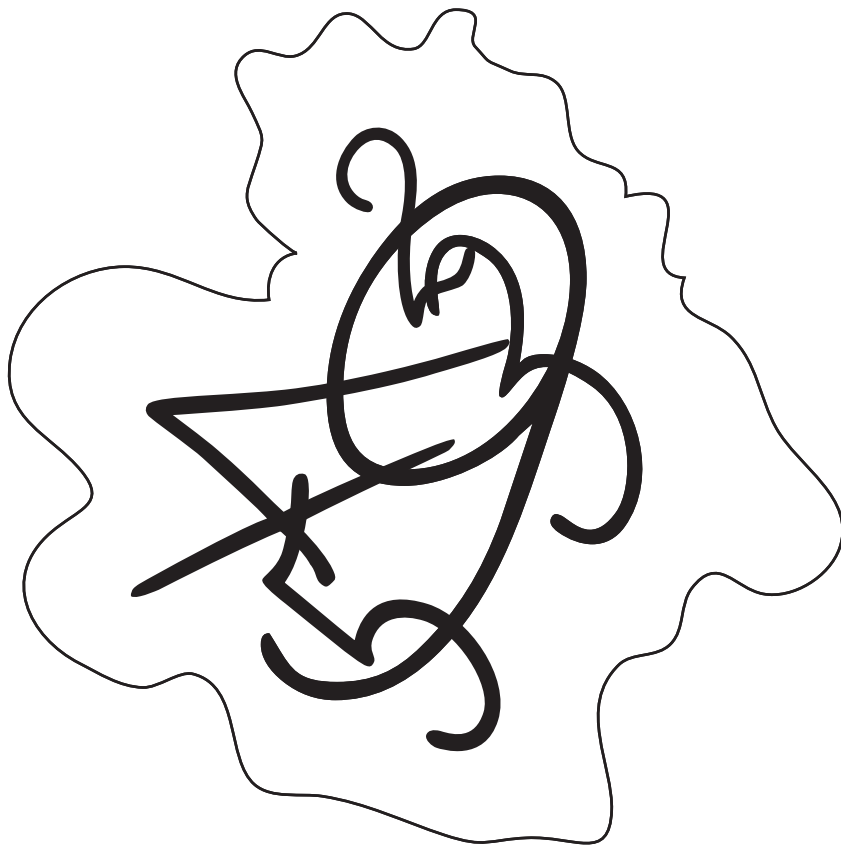



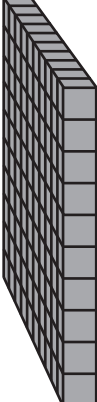

Приложение 17, занятие 12

Карточки «Острова»

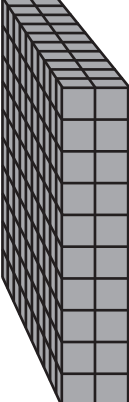

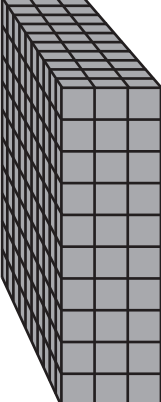
Приложение 21, занятие 18

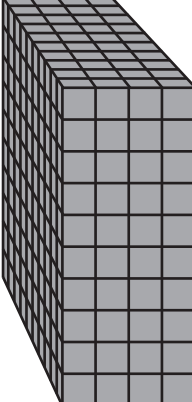
Рисунок «Единицы, десятки, сотни»

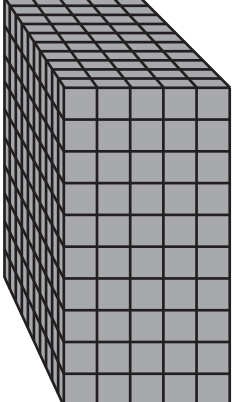
Единицы, десятки, сотни		
1		100
10		
2		200
20		
3		300
30		
4		400
40		
5		500
		

Приложение 23, занятие 22

Рисунок «Вычислительные «машины»»

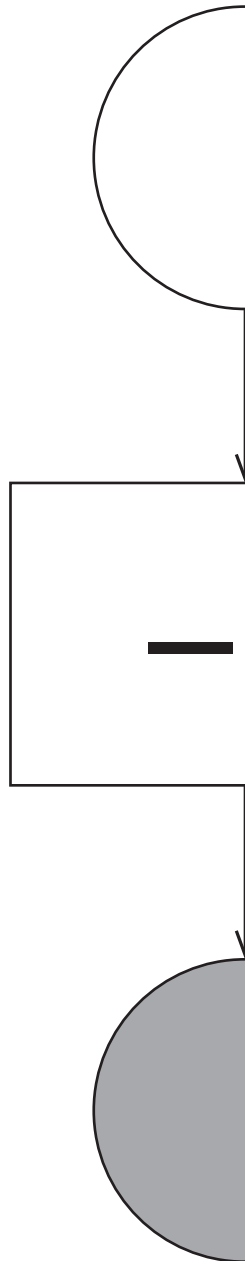
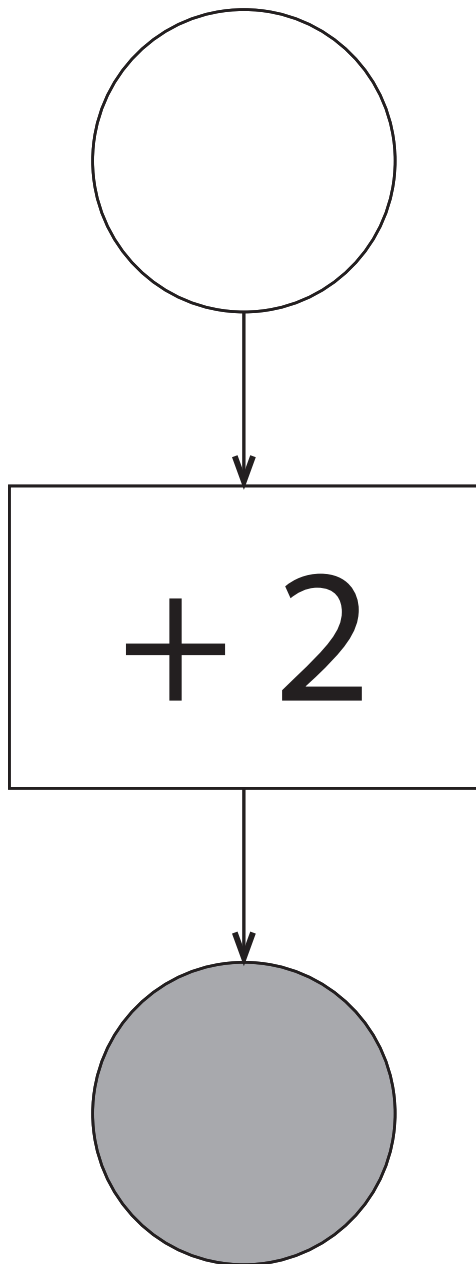

Приложение 24, занятие 26

Карточки «Найдите пару»

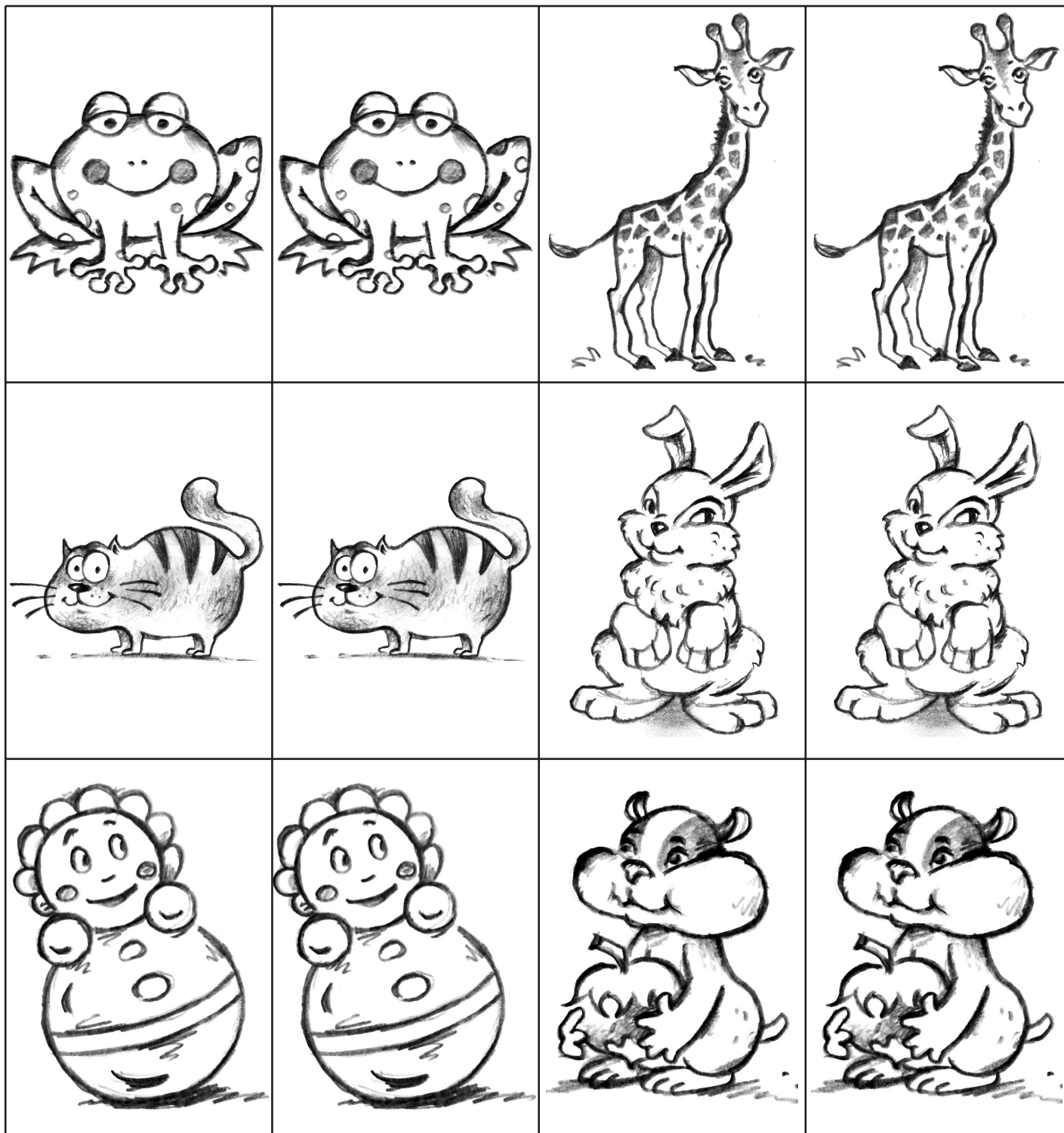

Приложение 28, занятие 31

Карточки «Емкости»

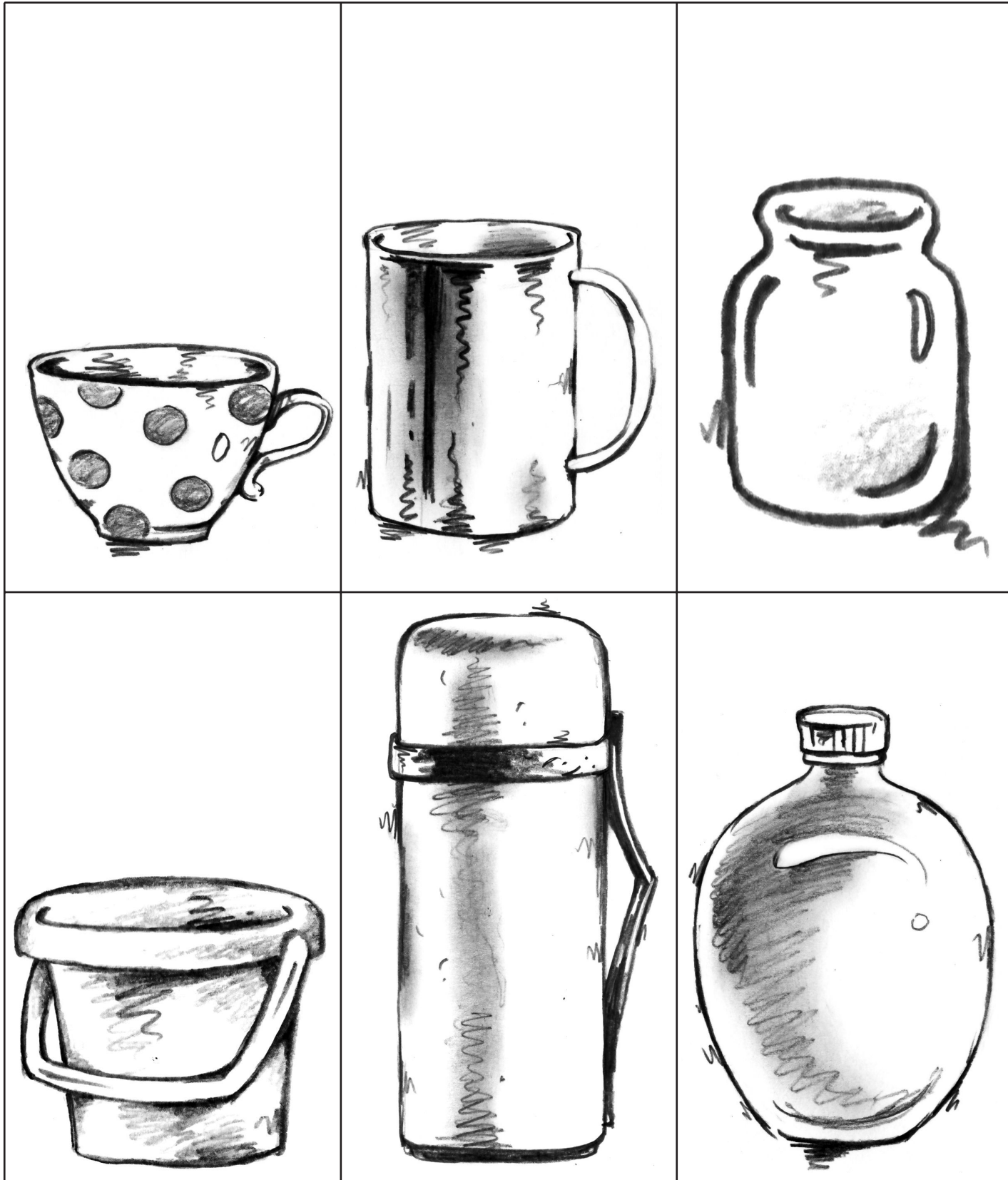

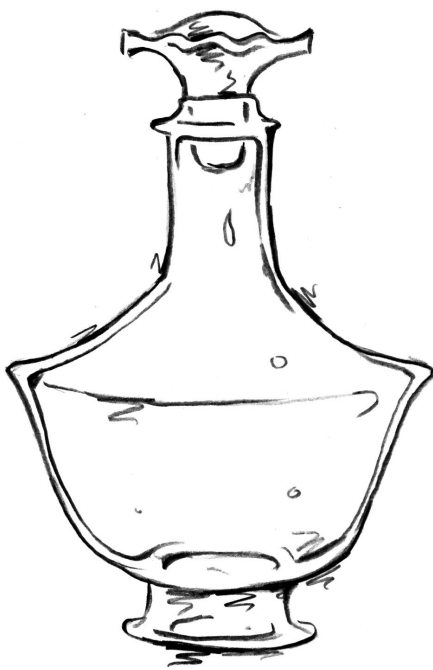
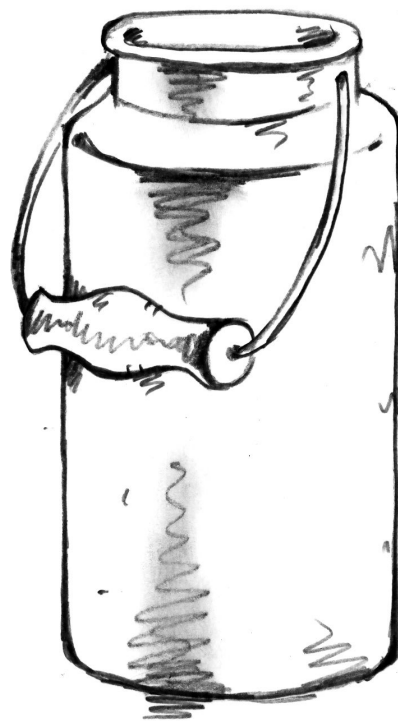

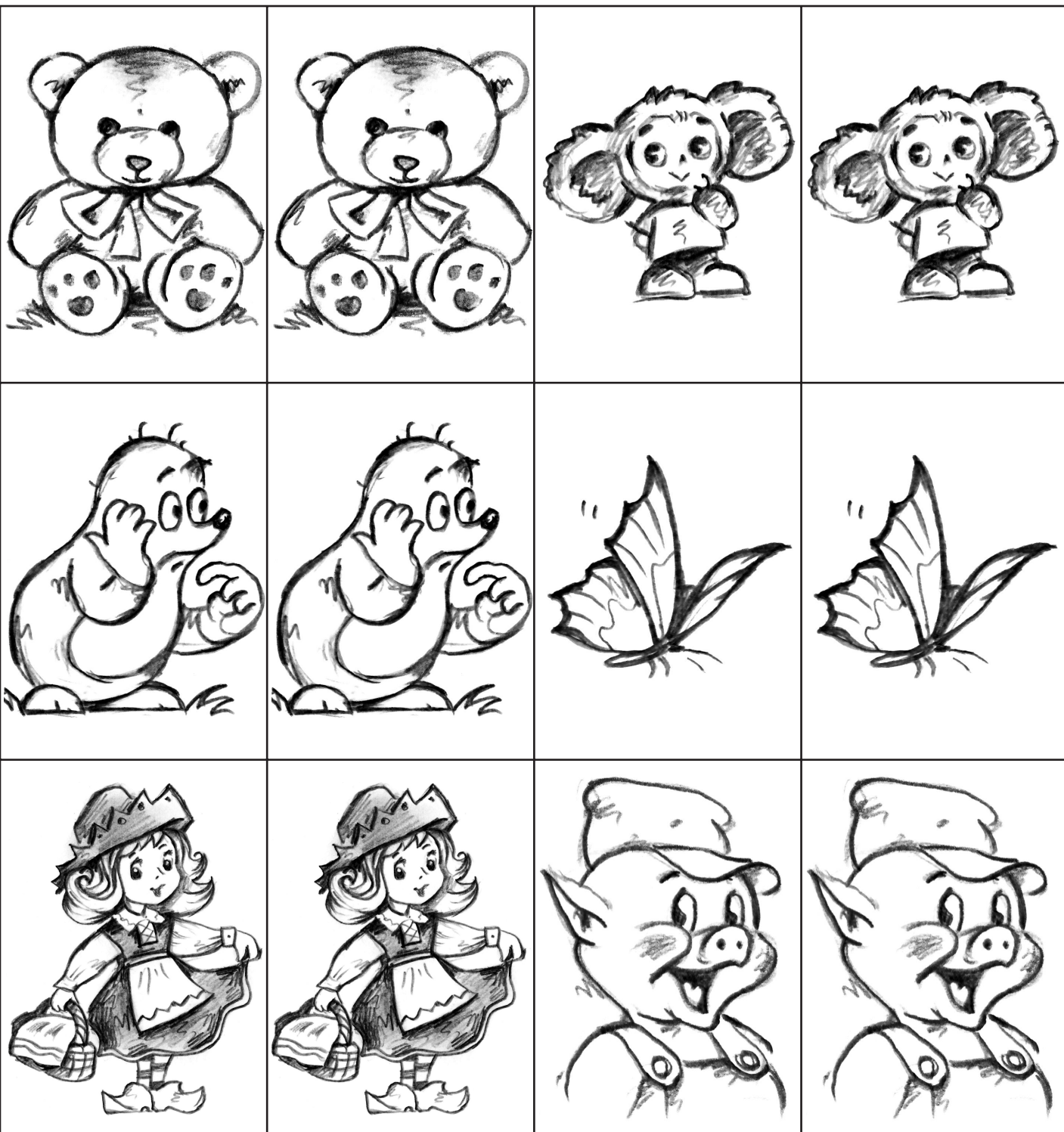

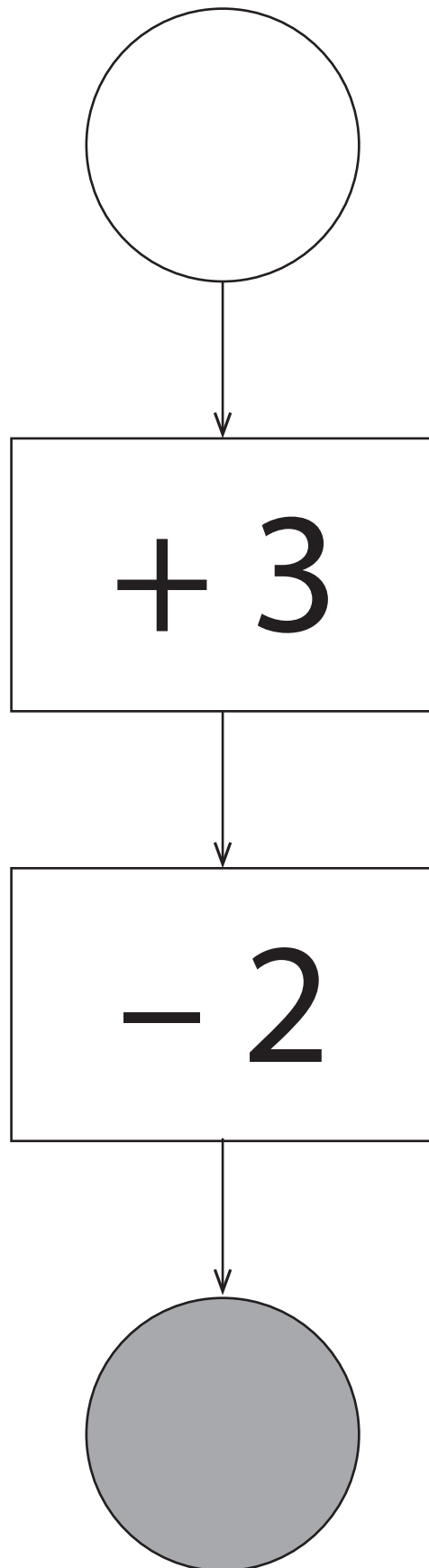

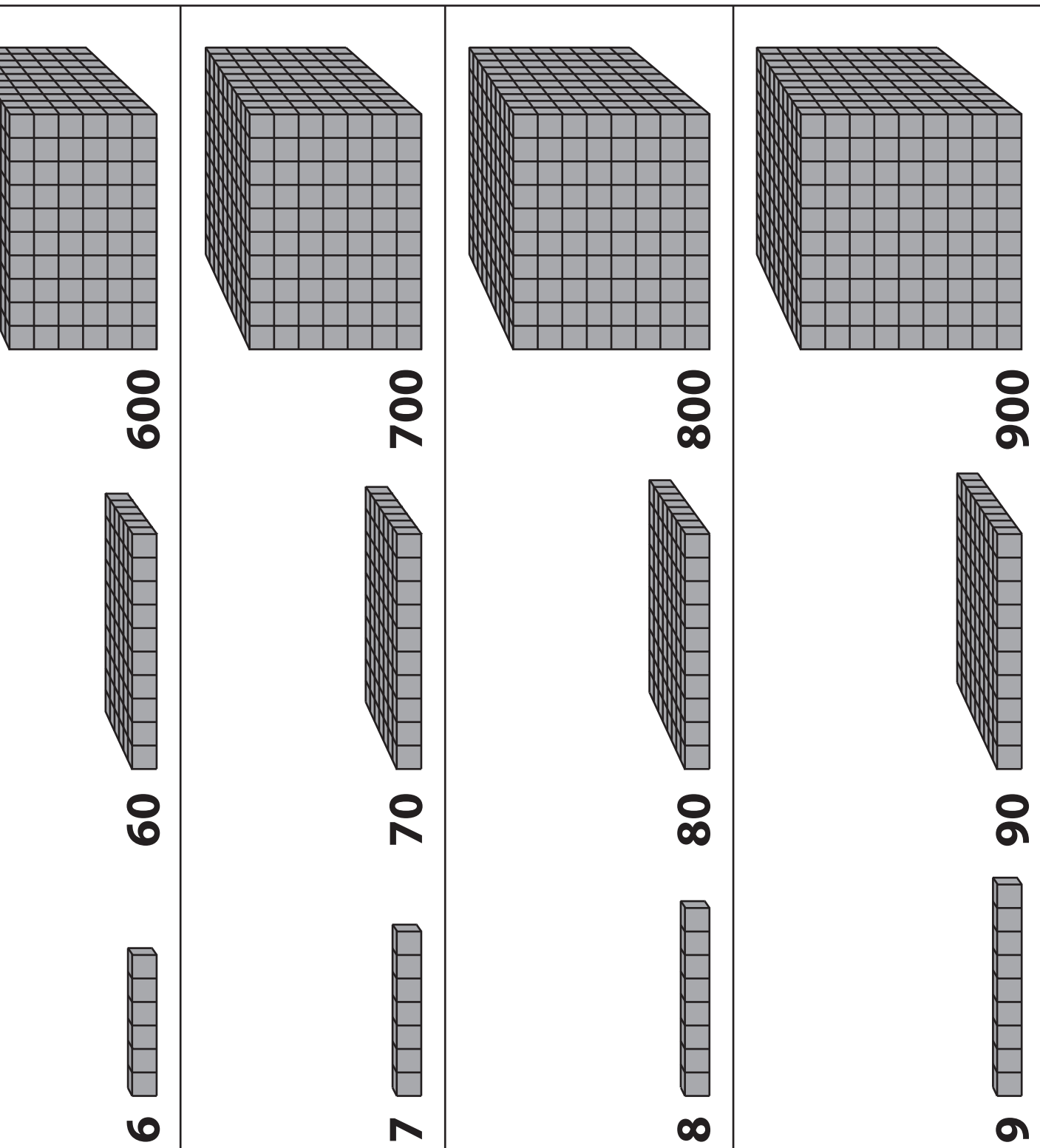

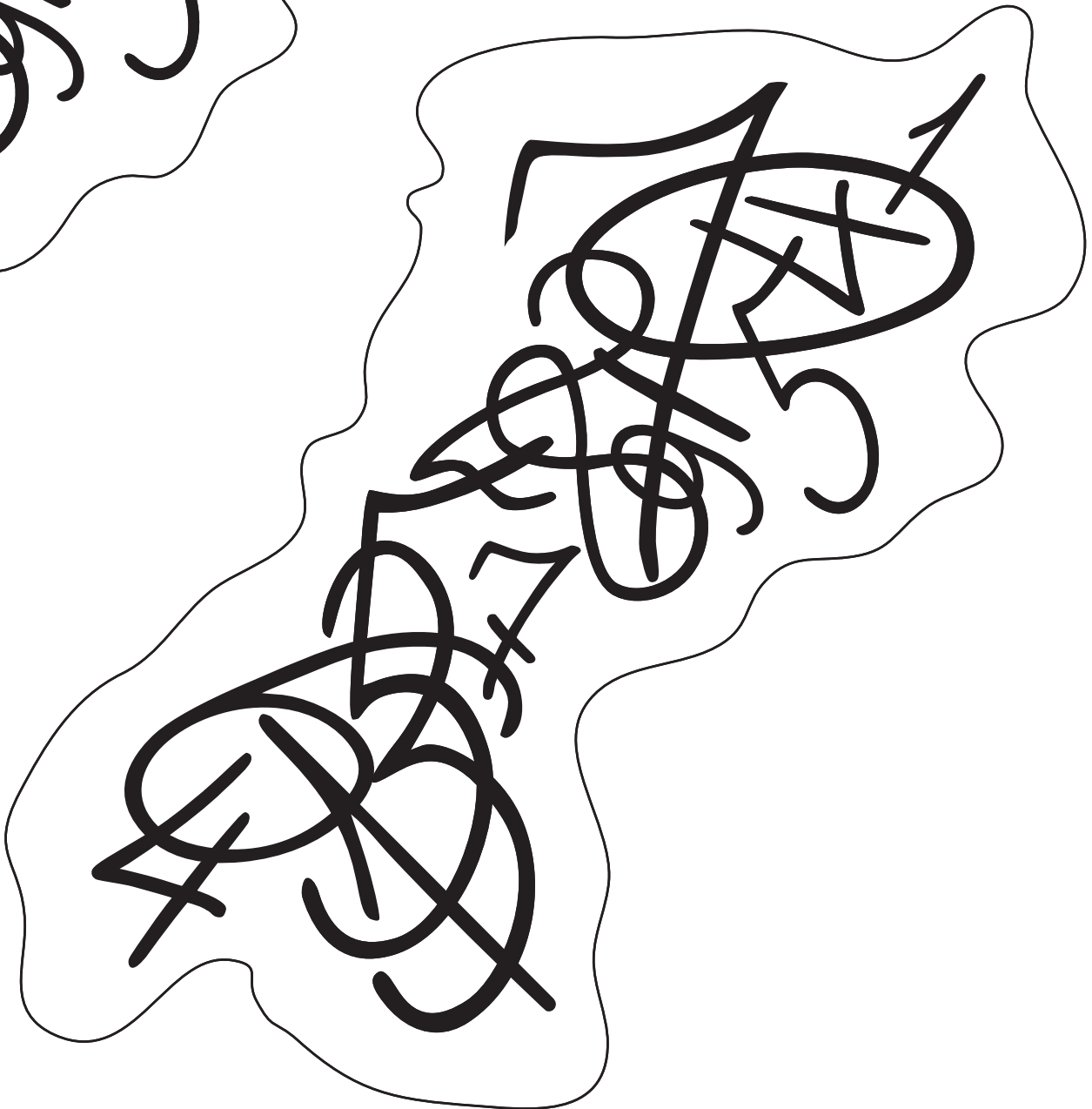

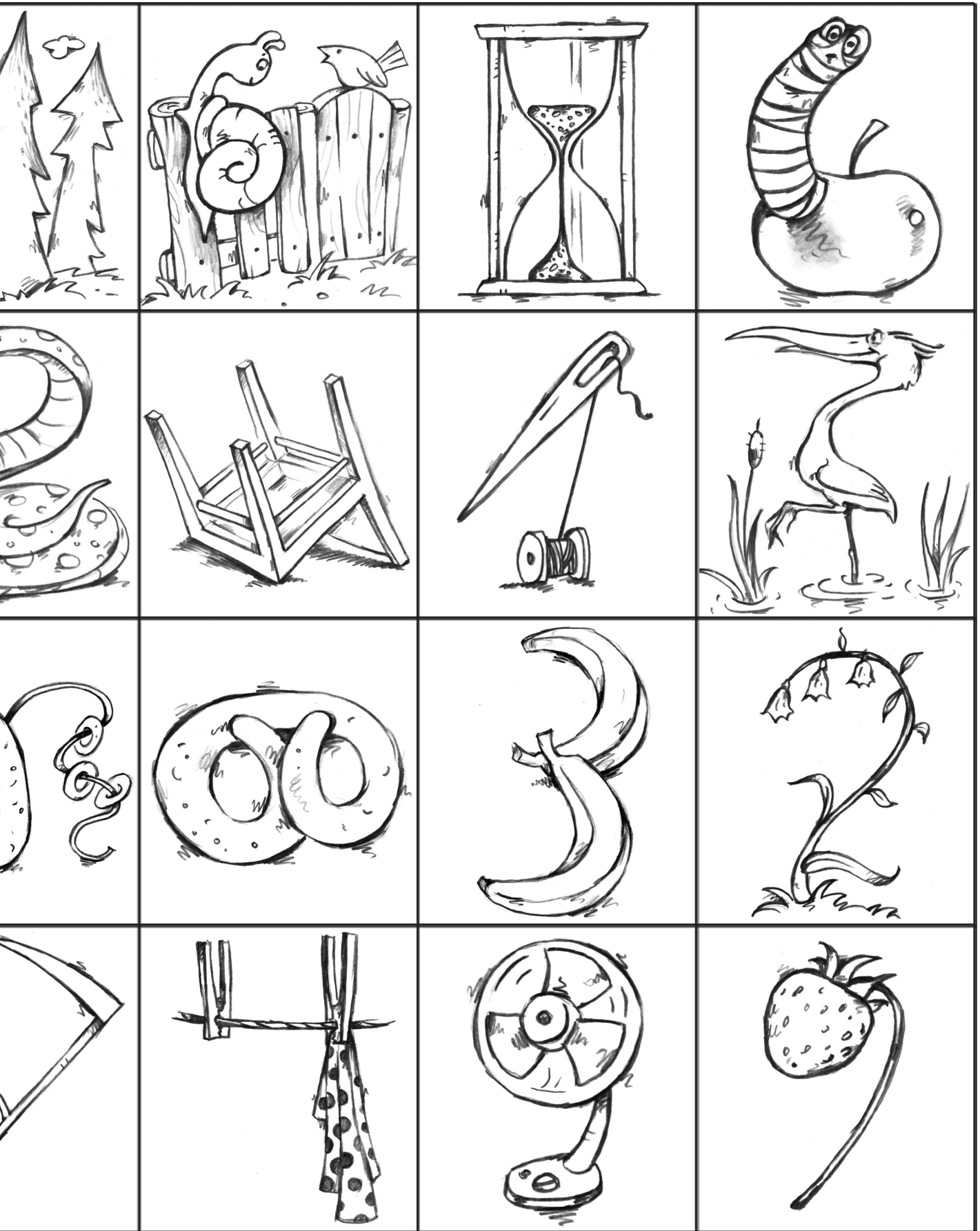



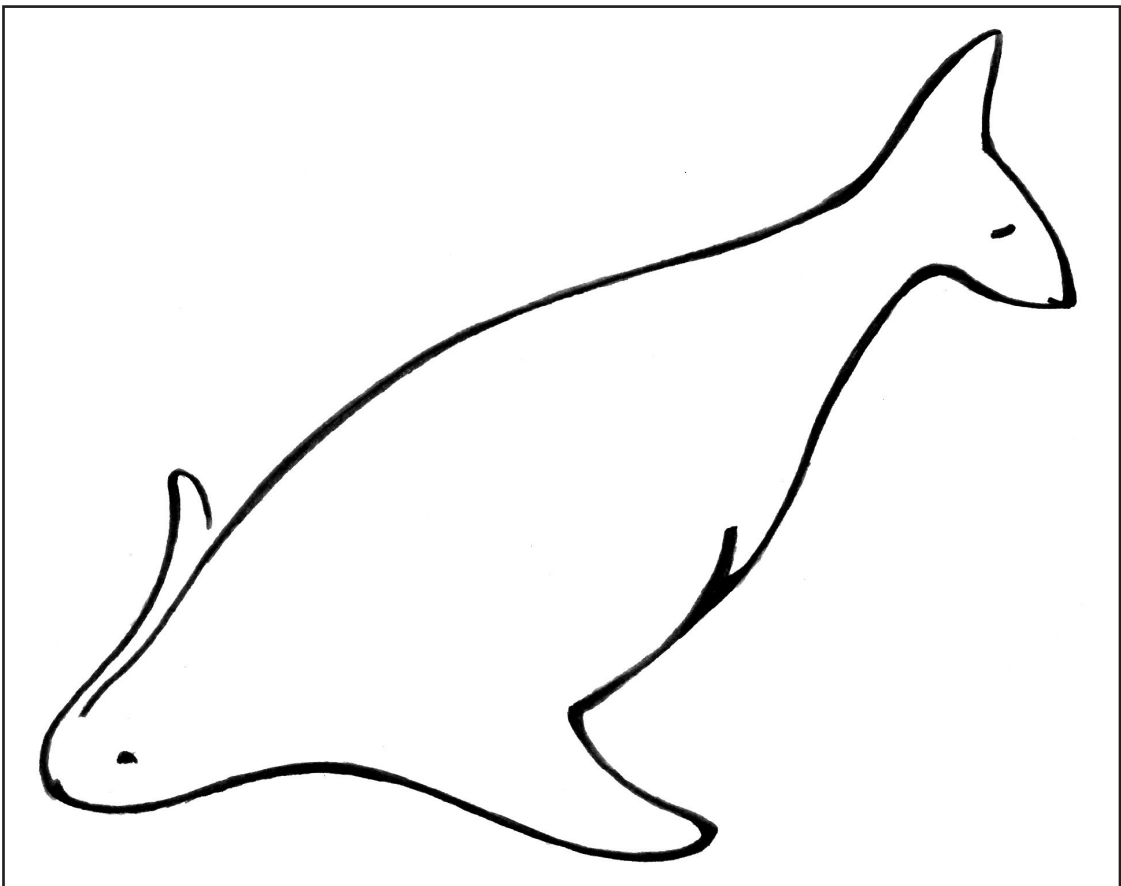
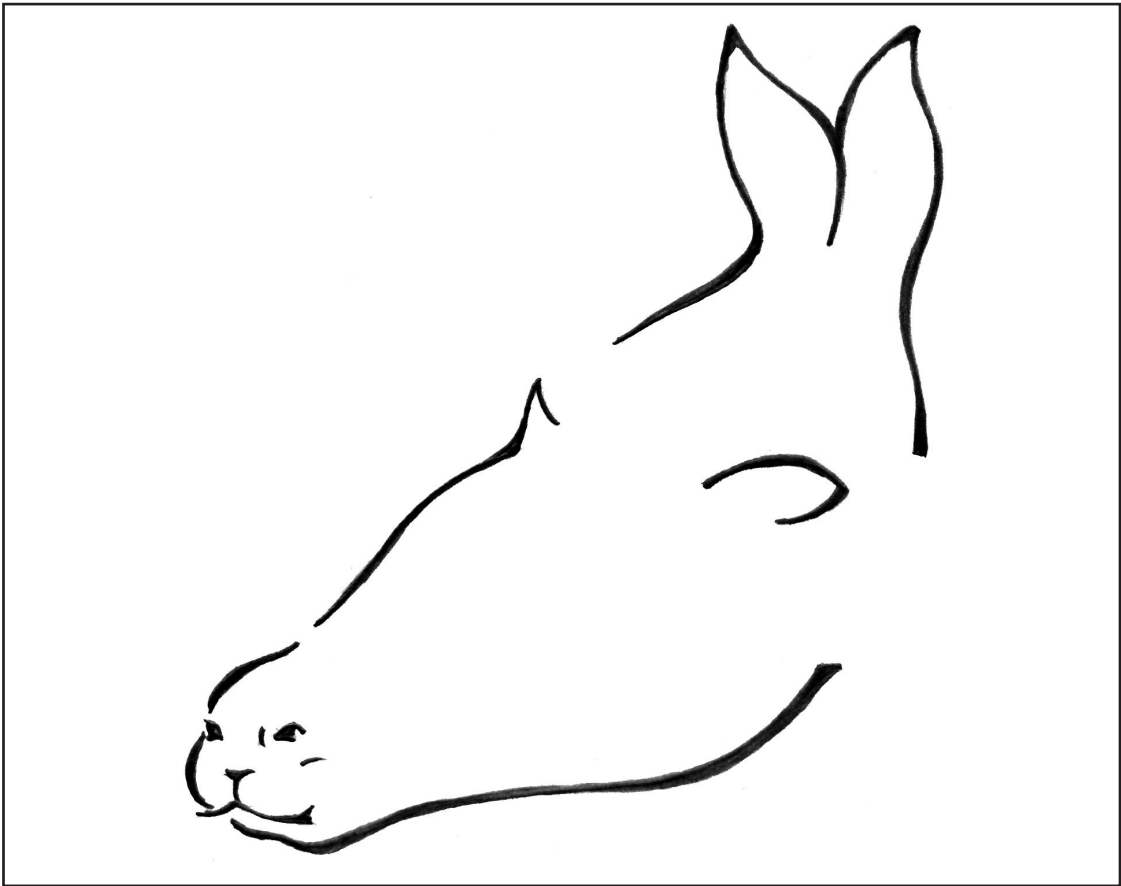

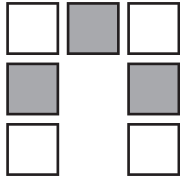
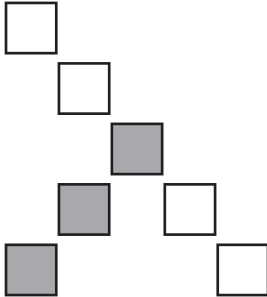
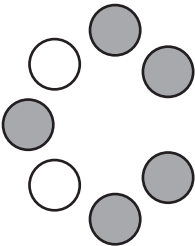
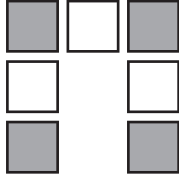
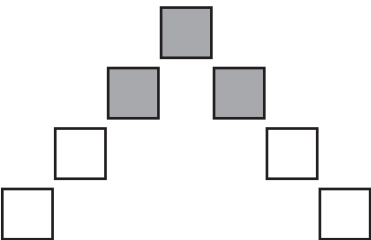
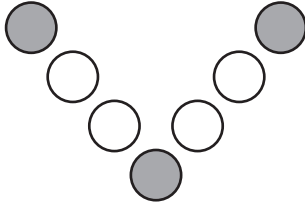
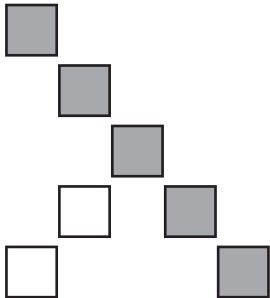
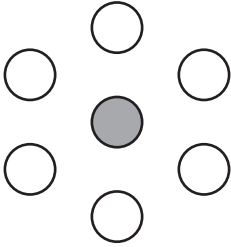
<p>3</p> 	<p>4</p> 
<p>7</p> 	<p>8</p> 
<p>11</p> 	<p>12</p> 
<p>15</p> 	<p>16</p> 

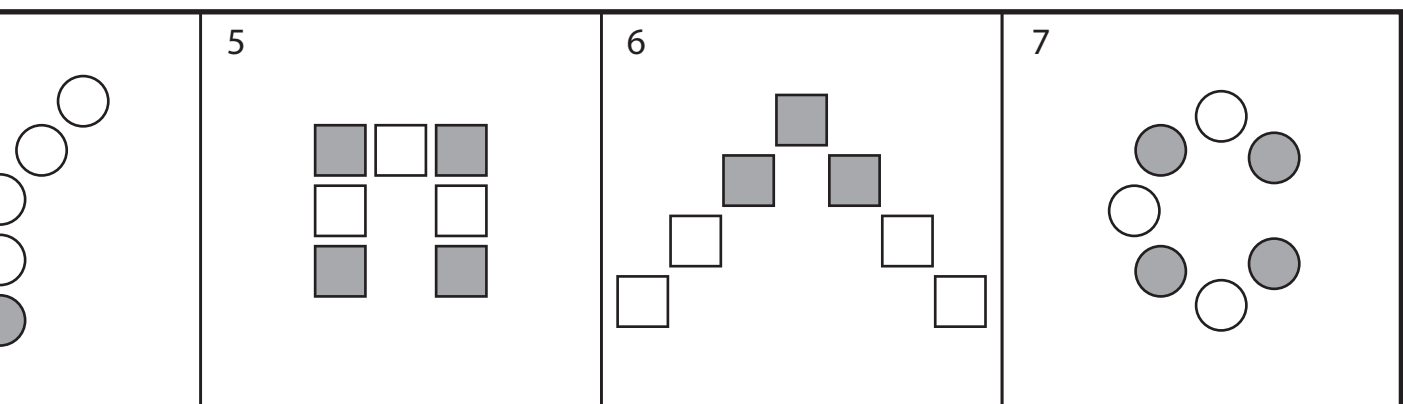
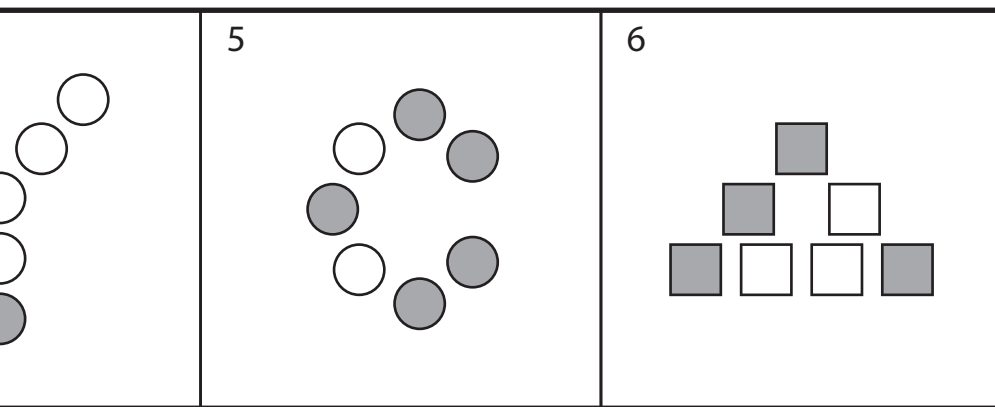
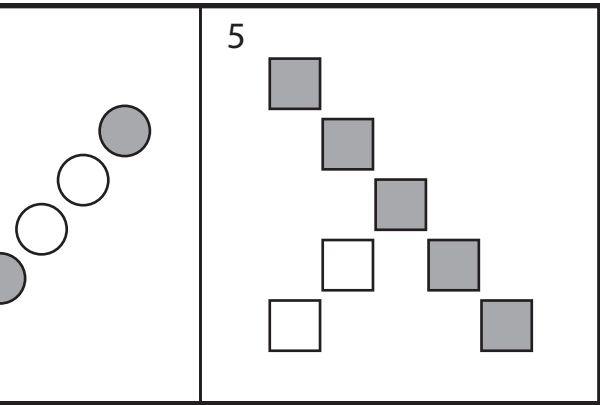

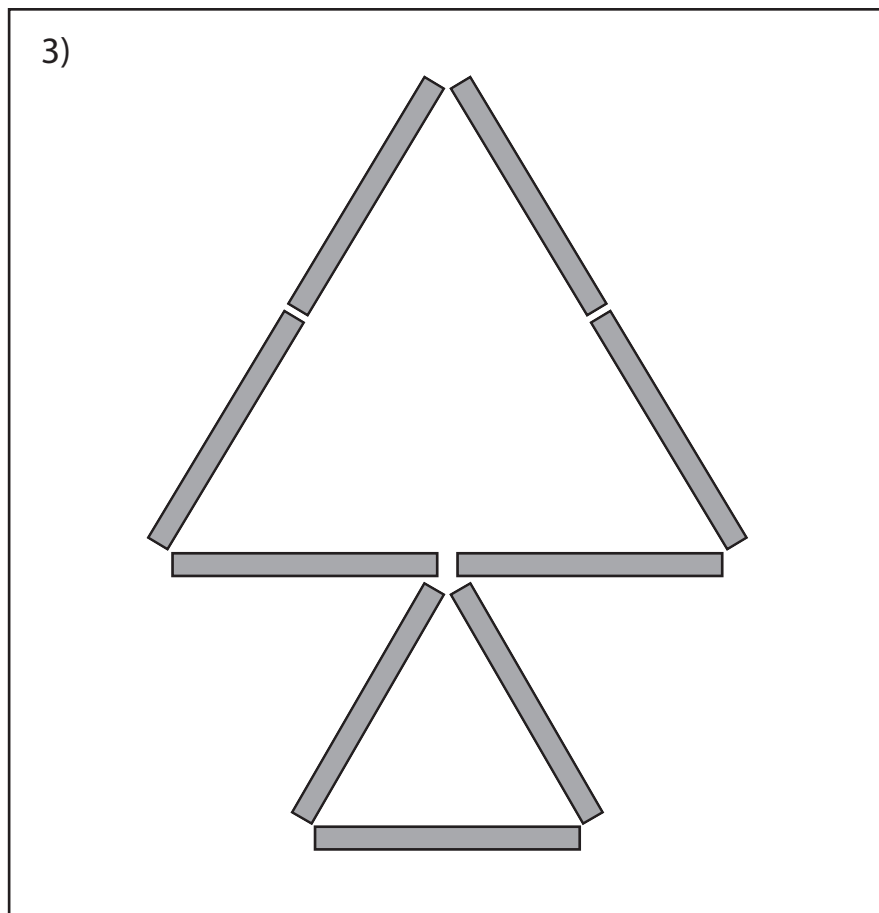
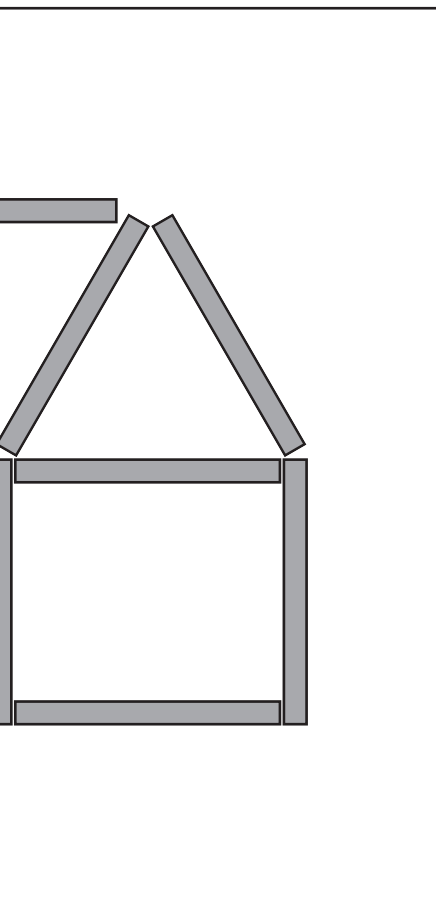

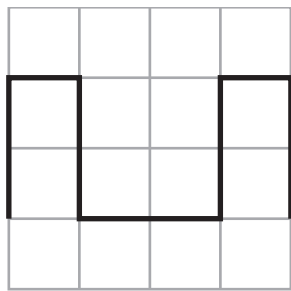

С

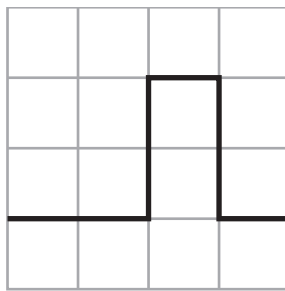

Т

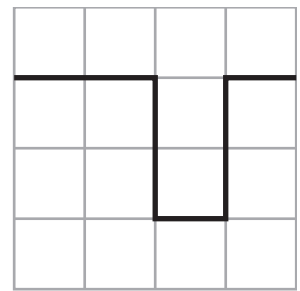

У

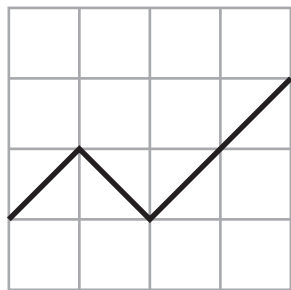

О

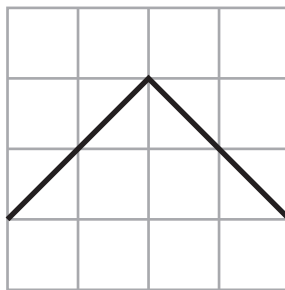

П

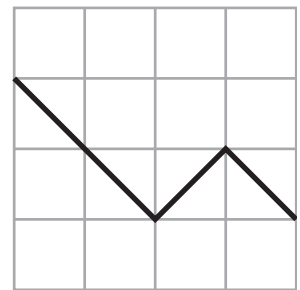

Р

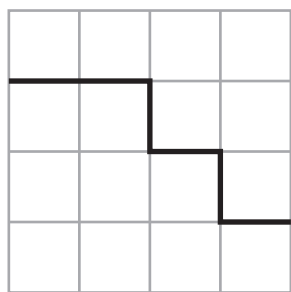

Н

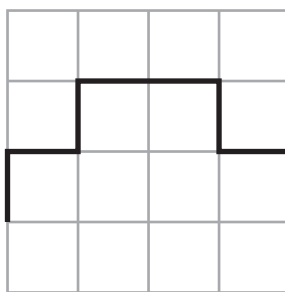

О

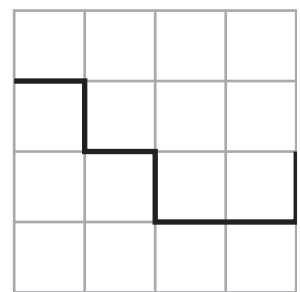

П

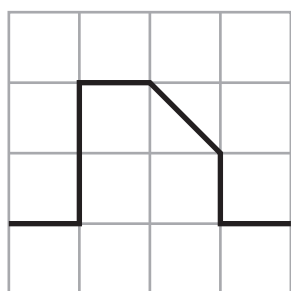

П

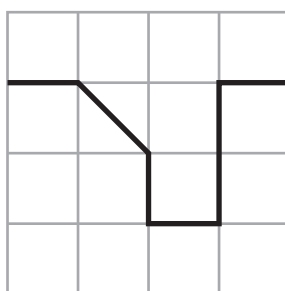

Р

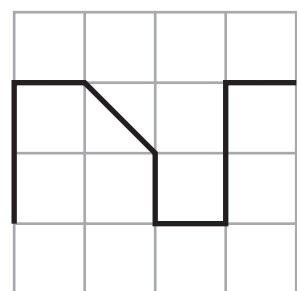

С

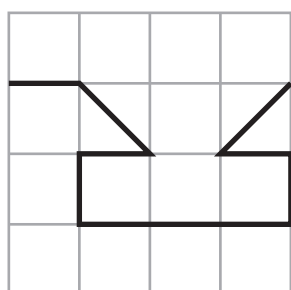

А

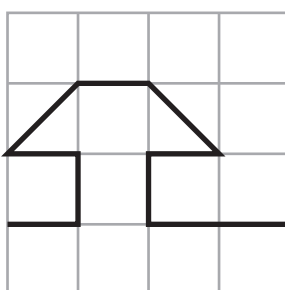

Б

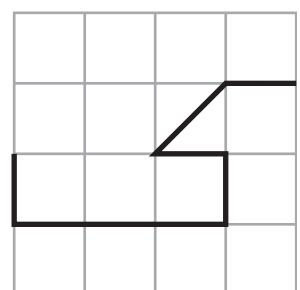

В

Приложение 15, занятие 11
Карточки «Цифры в зеркале»

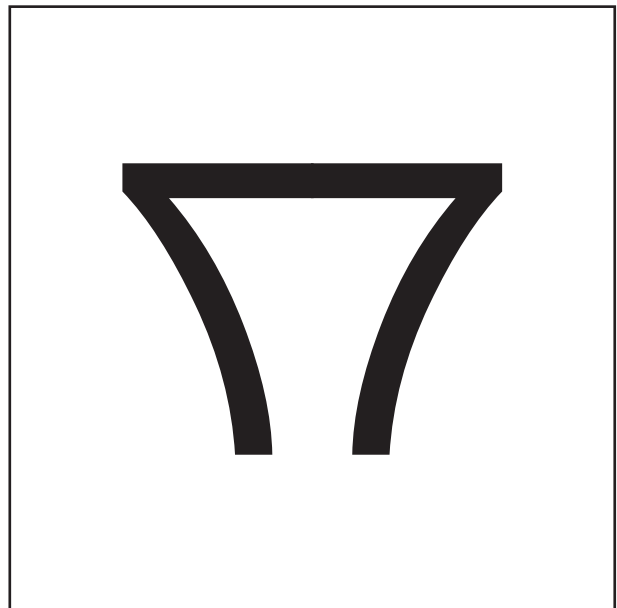
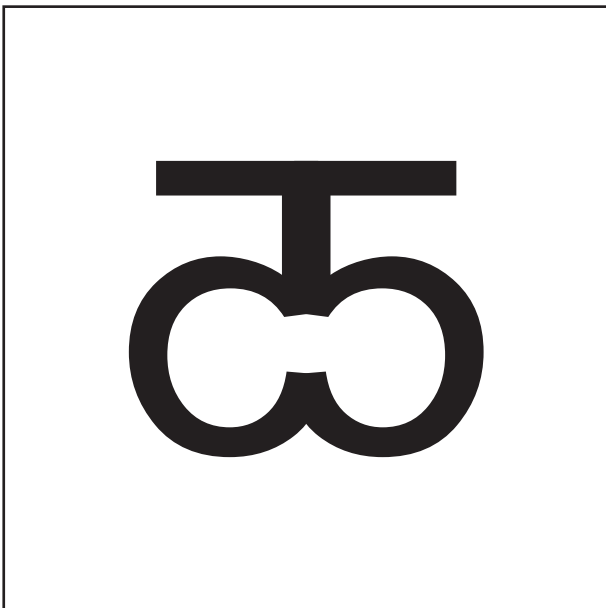
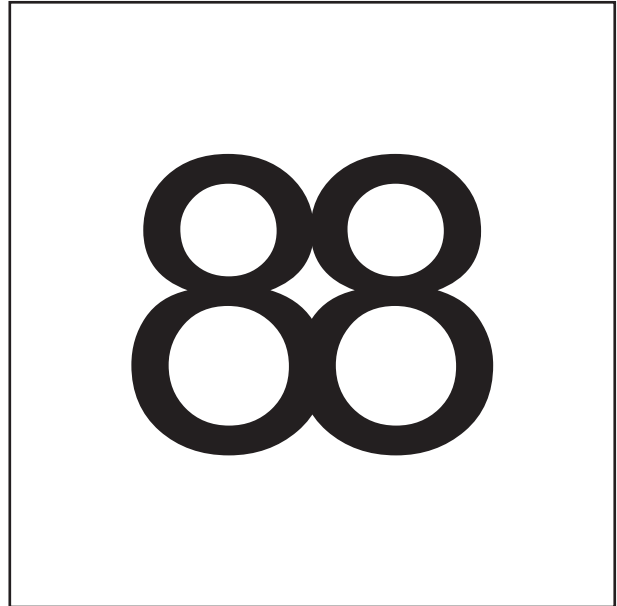
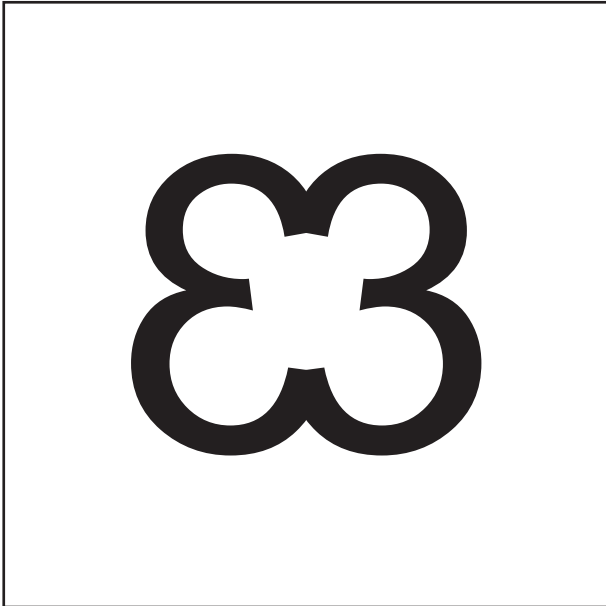

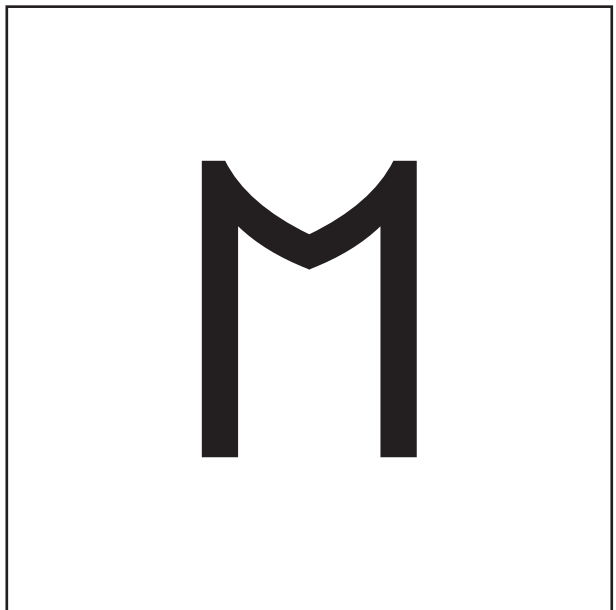
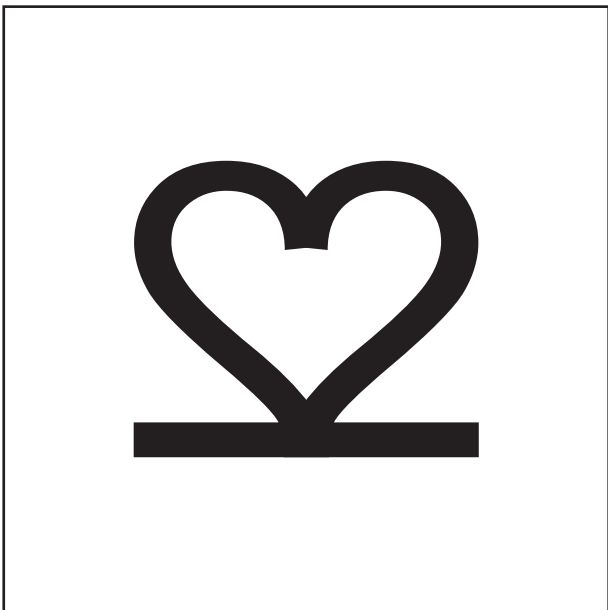
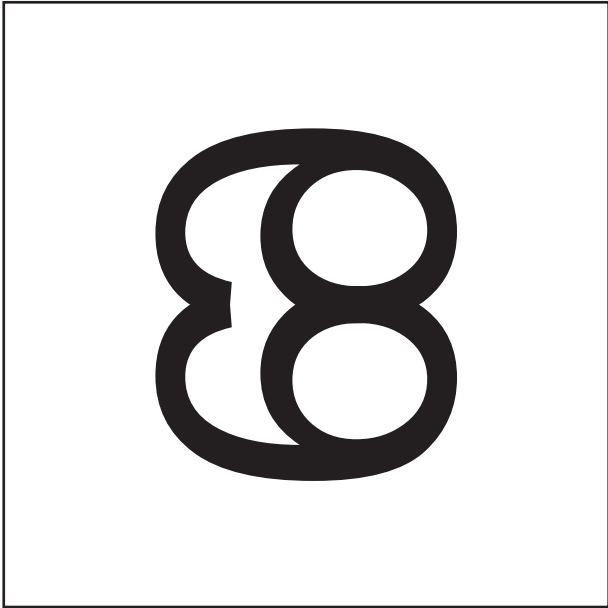

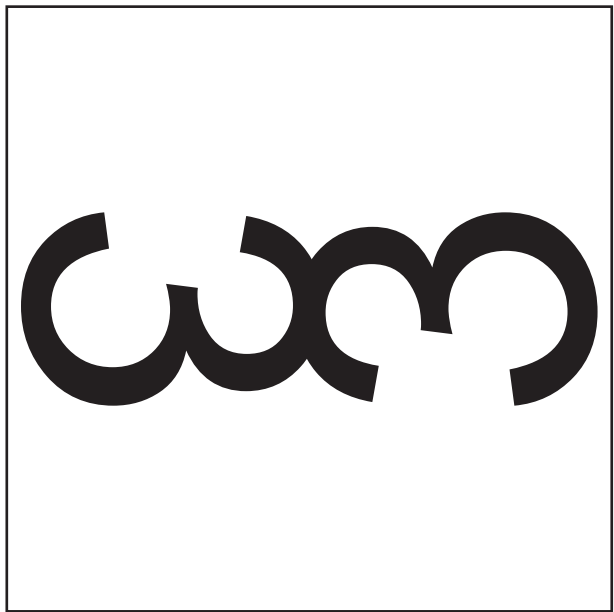
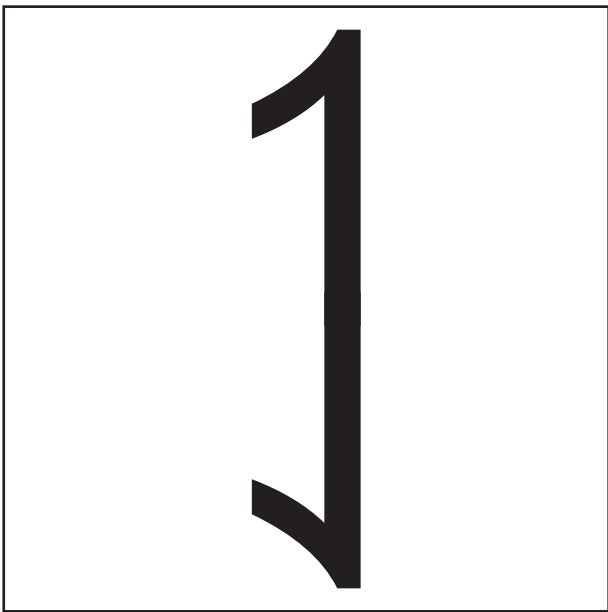
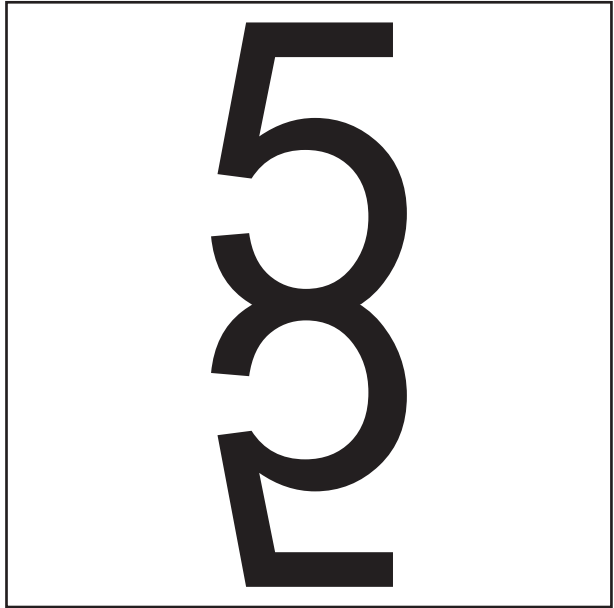
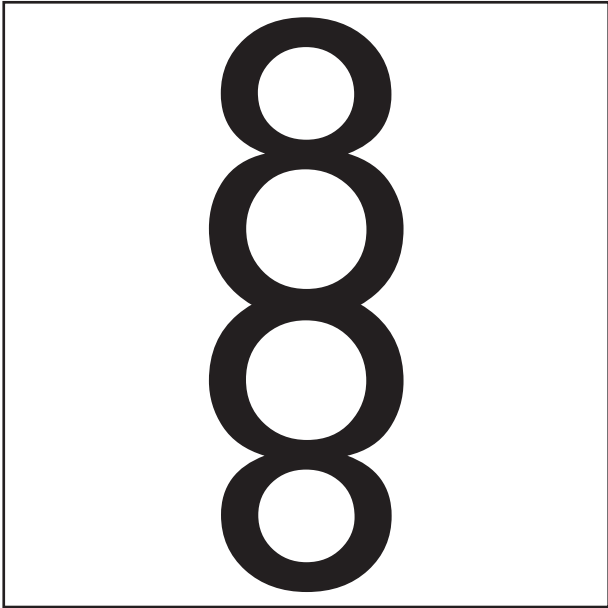

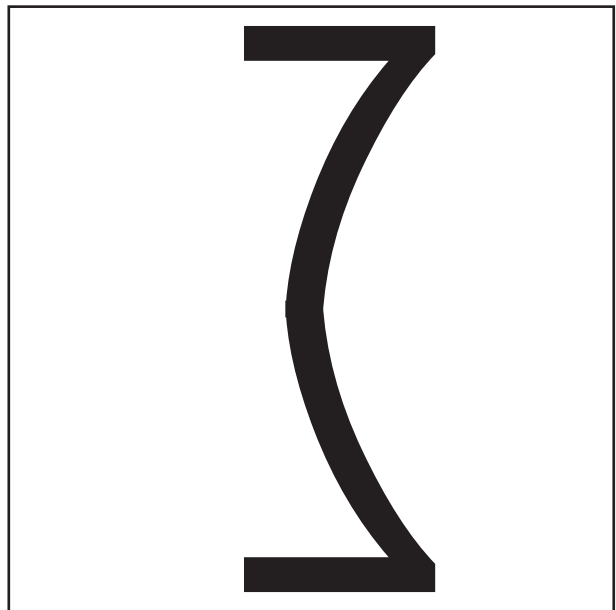
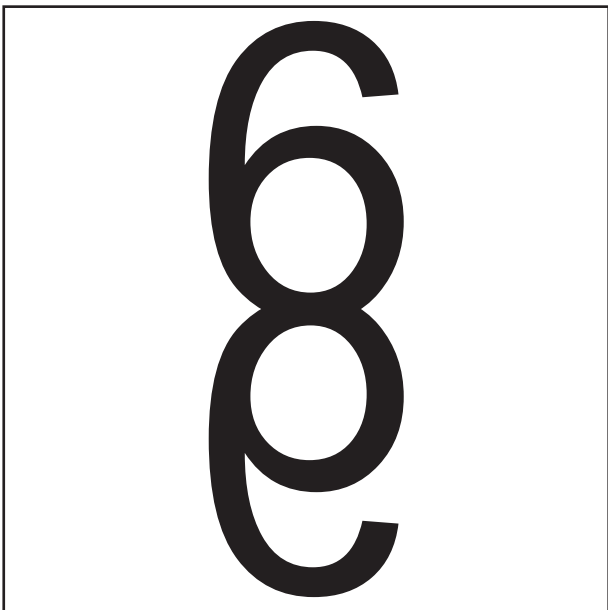
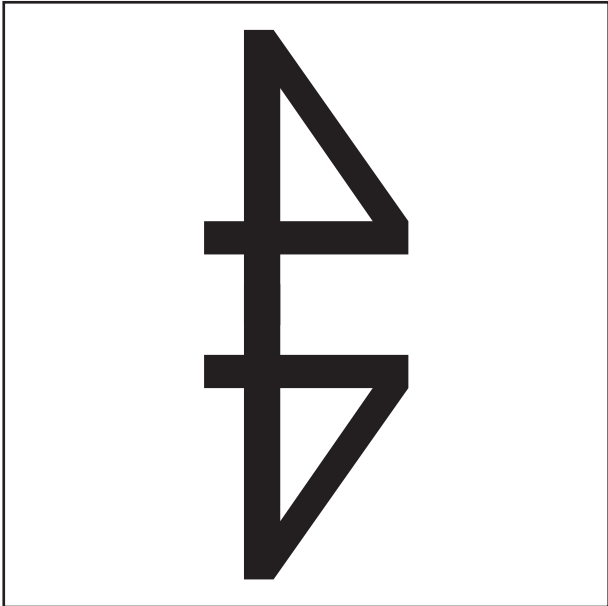

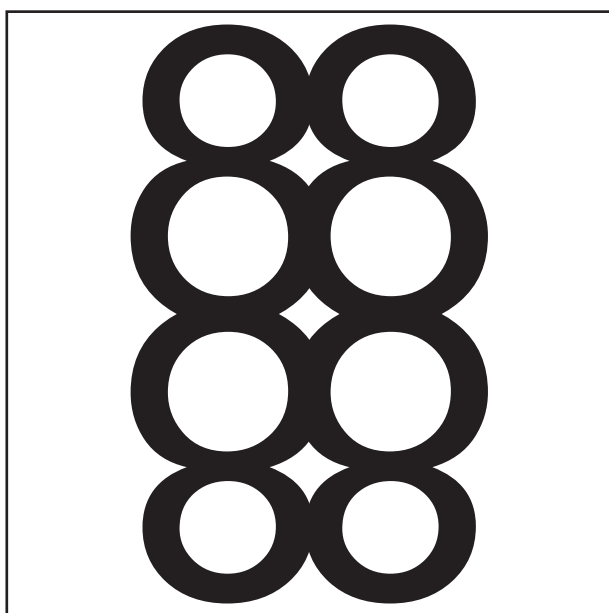
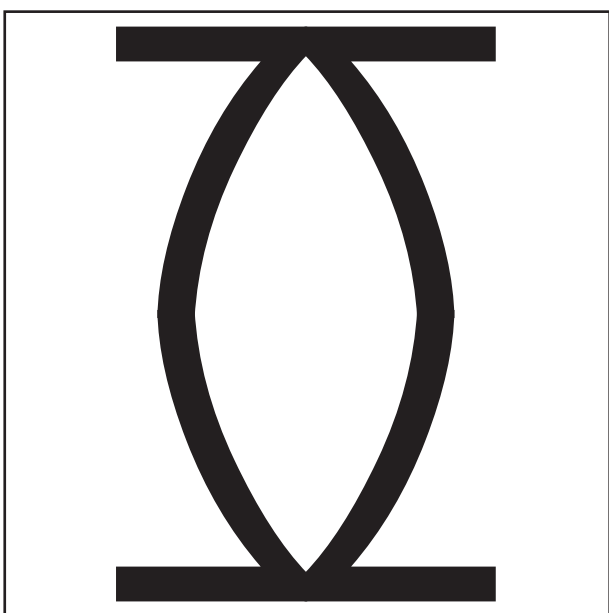
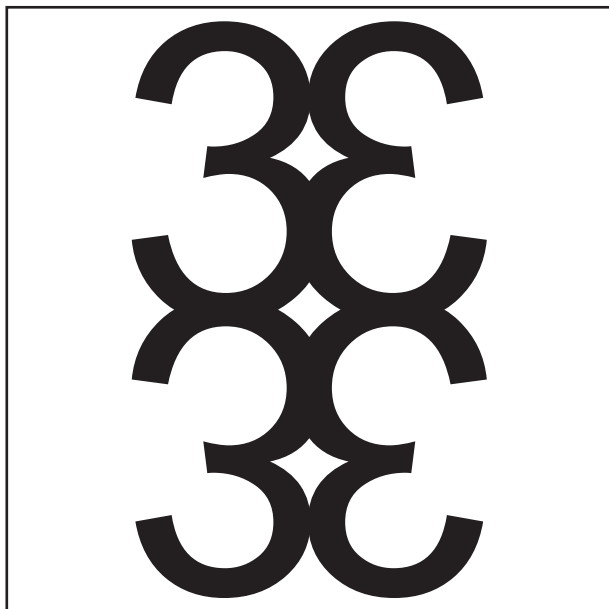
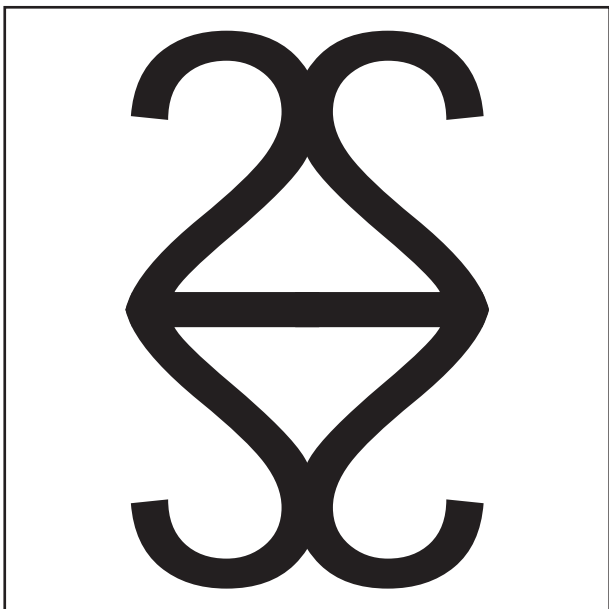

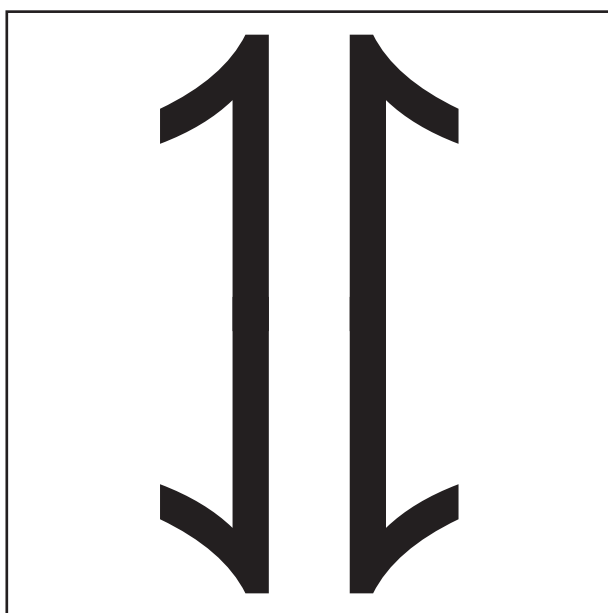
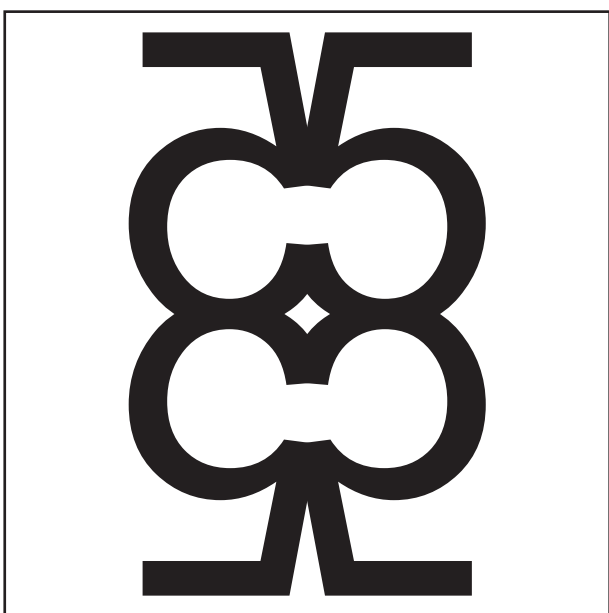
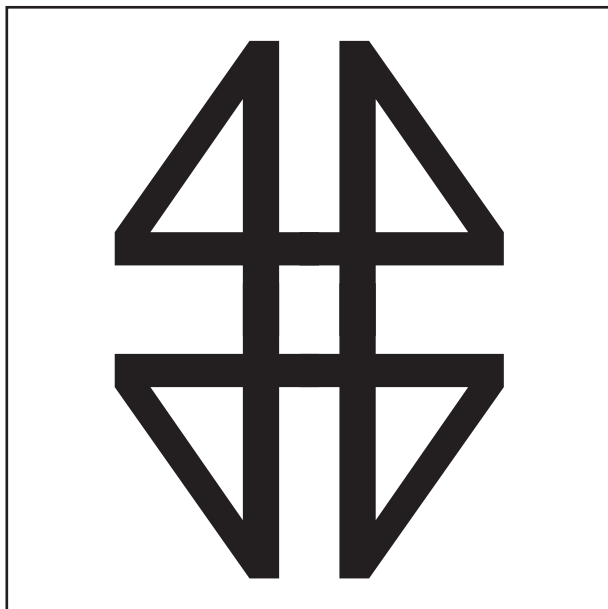
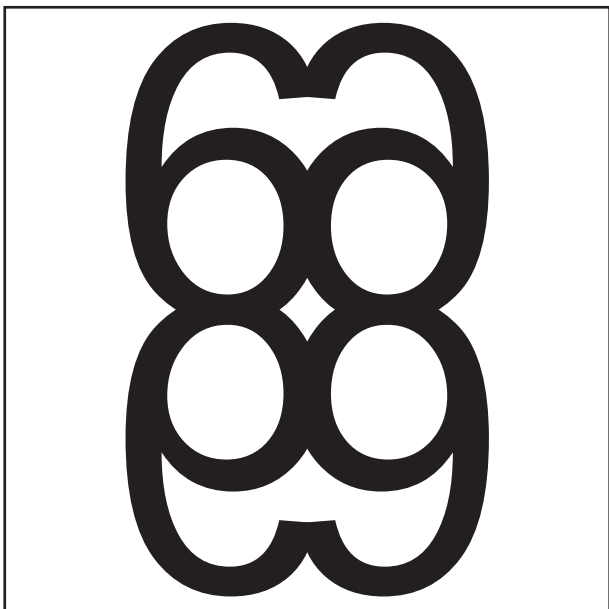

Приложение 19, занятие 15
Карточки «Парные картинки»

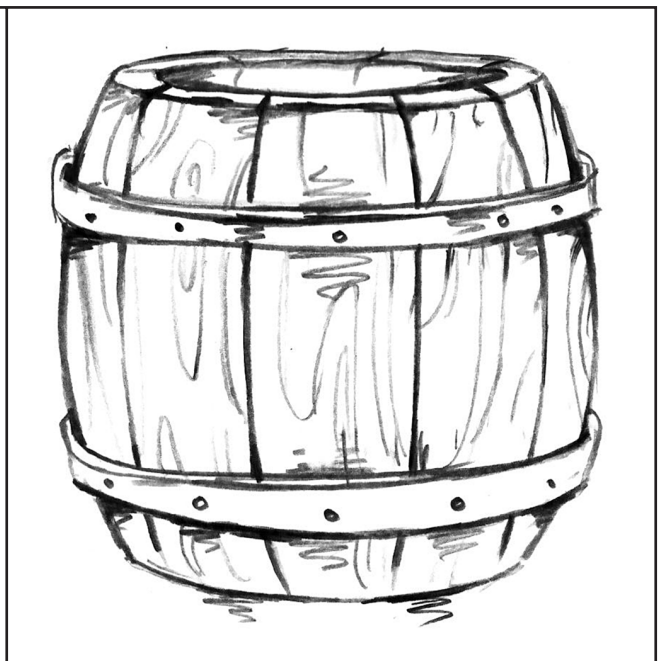
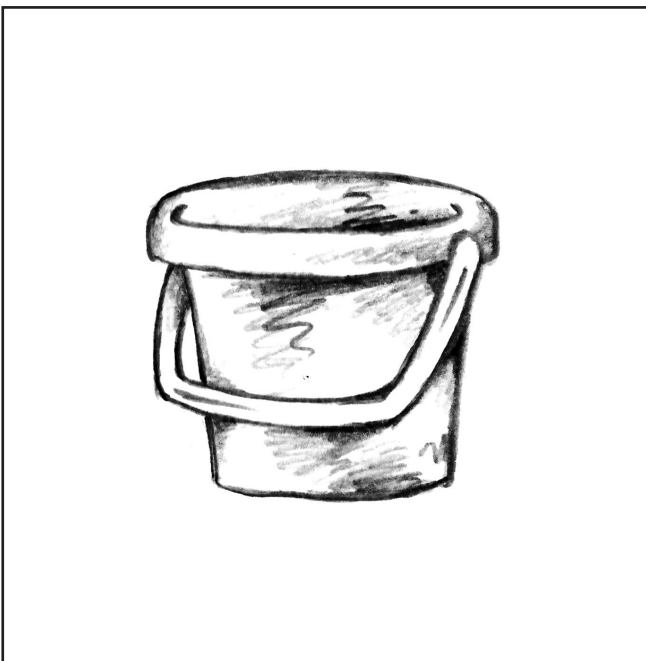
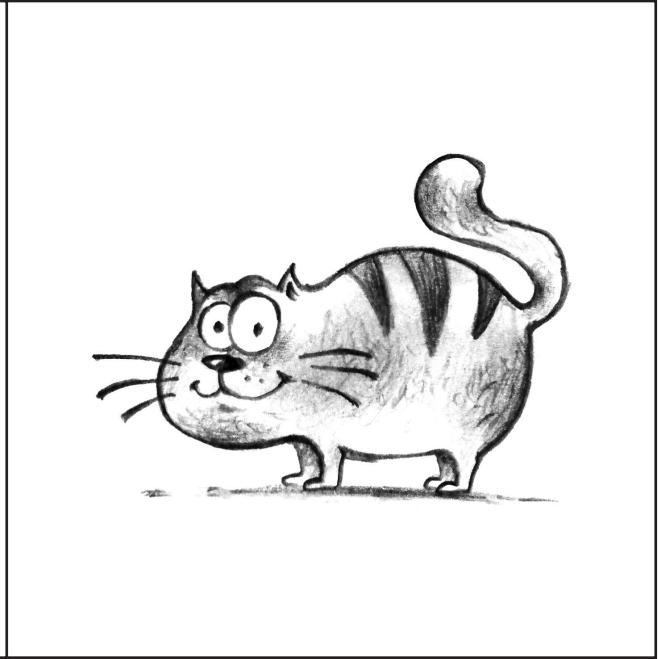
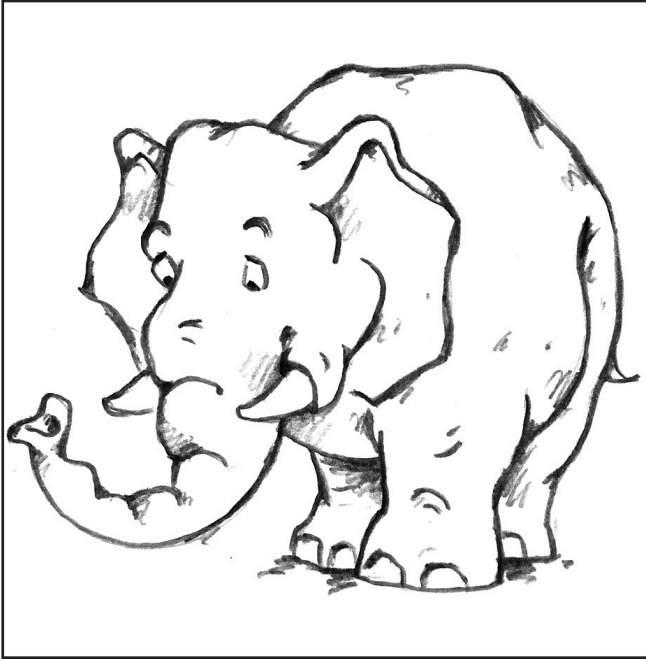

Приложение 20, занятие 16

Карточки «Детективы»

Шерлок
Холмс



Шерлок
Холмс



Эркюль
Пуаро



Эркюль
Пуаро



Лейтенант
Коломбо

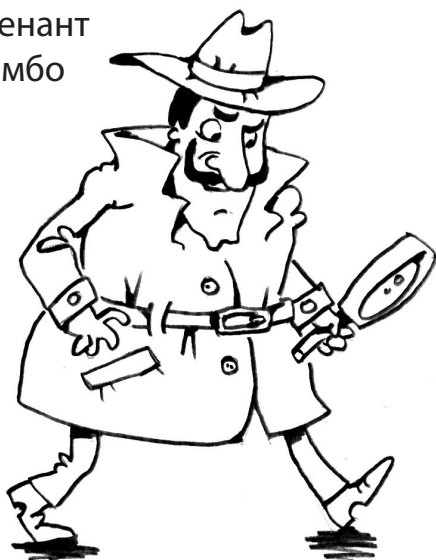

Лейтенант
Коломбо



Приложение 22, занятие 22

Рисунок «Древний абак»

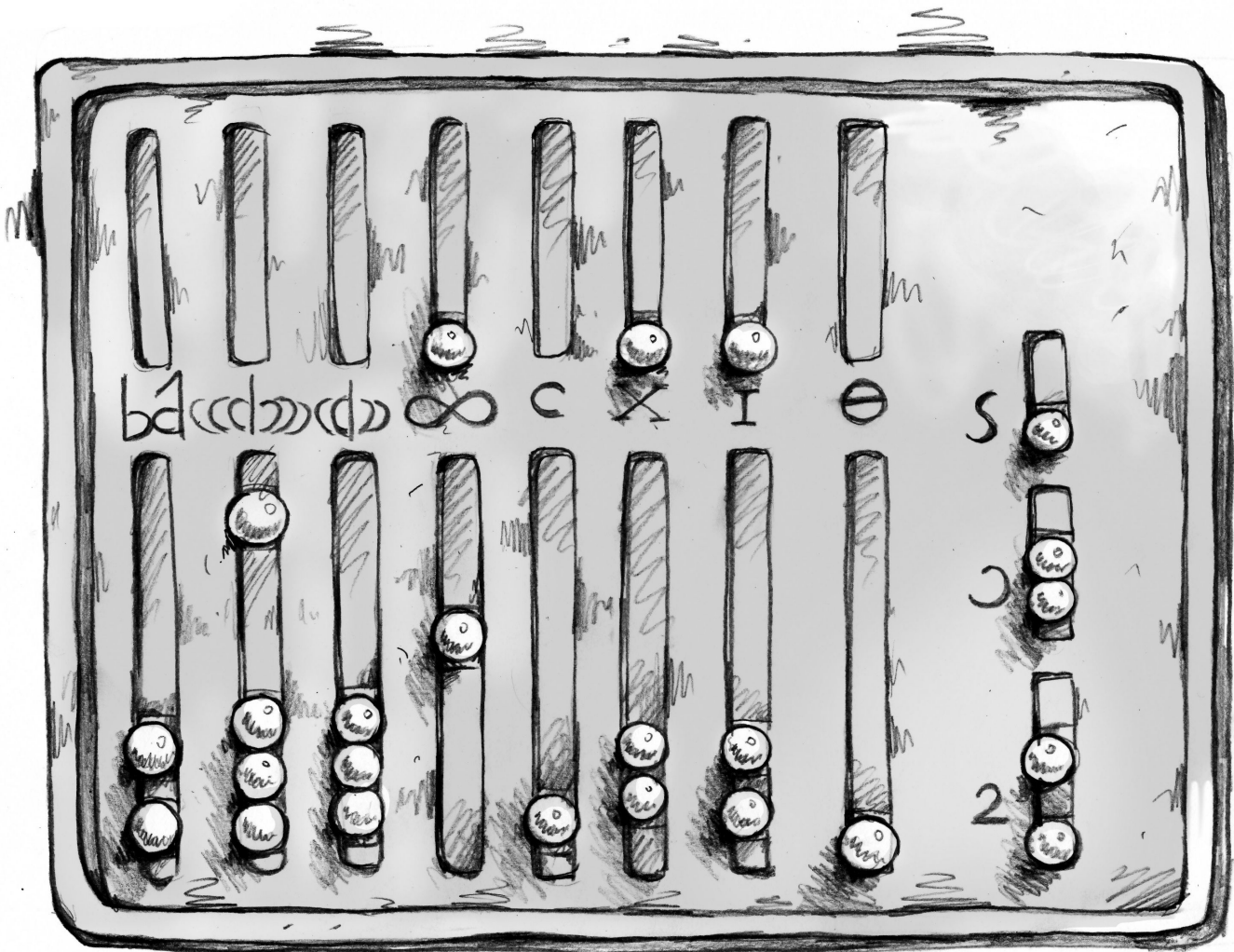

Приложение 25, занятие 28

Рисунки «Схемы задач»

<p>Было — <input type="text"/></p> <p>Добавили — <input type="text"/></p> <hr/> <p>Стало — <input type="text"/></p>	<p>I — <input type="text"/> } <input type="text"/></p> <p>II — <input type="text"/> }</p>	<p><input type="text"/> <input type="text"/></p> <p>— <input type="text"/></p> <p><input type="text"/></p>
<p>Было — <input type="text"/></p> <p>Добавили — <input type="text"/></p> <hr/> <p>Стало — <input type="text"/></p>	<p>I — <input type="text"/> } <input type="text"/></p> <p>II — <input type="text"/> }</p>	<p><input type="text"/> <input type="text"/></p> <p>— <input type="text"/></p> <p><input type="text"/></p>

<p>Было — <input type="text"/></p> <p>Добавили — <input type="text"/></p> <hr/> <p>Стало — <input type="text"/></p>	<p>I — <input type="text"/> } <input type="text"/></p> <p>II — <input type="text"/> }</p>	<p><input type="text"/> <input type="text"/></p> <p>— <input type="text"/></p> <p><input type="text"/></p>
<p>Было — <input type="text"/></p> <p>Добавили — <input type="text"/></p> <hr/> <p>Стало — <input type="text"/></p>	<p>I — <input type="text"/> } <input type="text"/></p> <p>II — <input type="text"/> }</p>	<p><input type="text"/> <input type="text"/></p> <p>— <input type="text"/></p> <p><input type="text"/></p>

Приложение 26, занятие 29

Карточки «Вопросы»

	?		
?			
			?

			?
	?		
		?	

	?		
?			
			?
		?	

		?	
	?		?
?			

Приложение 27, занятие 30
Рисунок «Дорожные указатели»

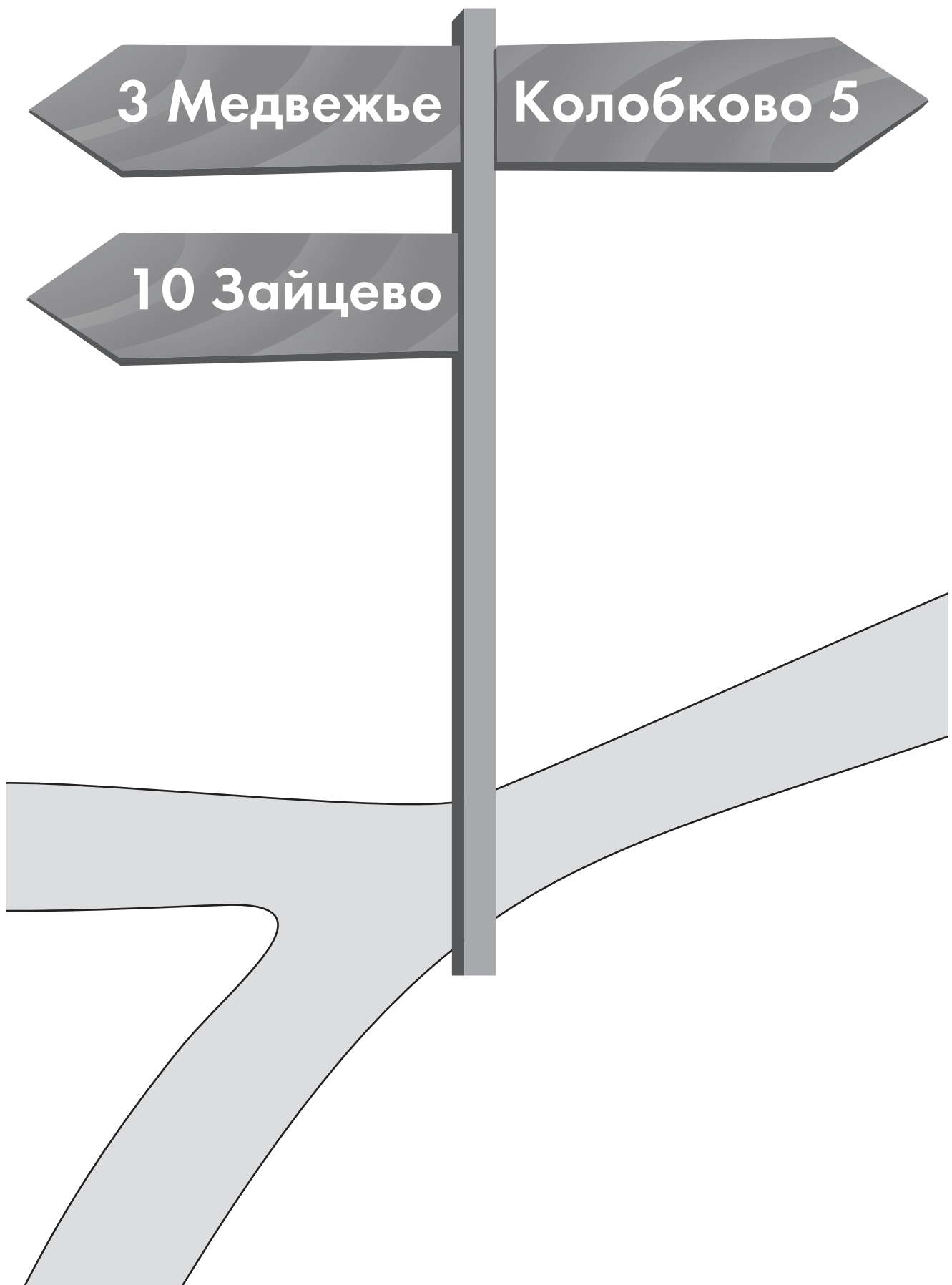

Приложение 29, занятие 33

Карточки «Весы»

