

ПРИЛОЖЕНИЕ



к пособию для учителей
**«Математическая радуга.
Факультативные занятия
в 3 классе»**

Для работы с приложением его необходимо снять со скобы.
Некоторые карточки нужно разрезать.
Приложения 9, 10, 47, 51, 53, 54, 57 размещены
на сайте издательства www.aversev.by (раздел «Скачать»).

Приложение 56, занятие 34

189 763

190 998

Приложение 56, занятие 34

76

86

426 842

527 965

886 404

369 549

Приложение 56, занятие 34

19

20

83

58

910 112

134 718

594 370

932 572

Приложение 56, занятие 34

14

26

90

34

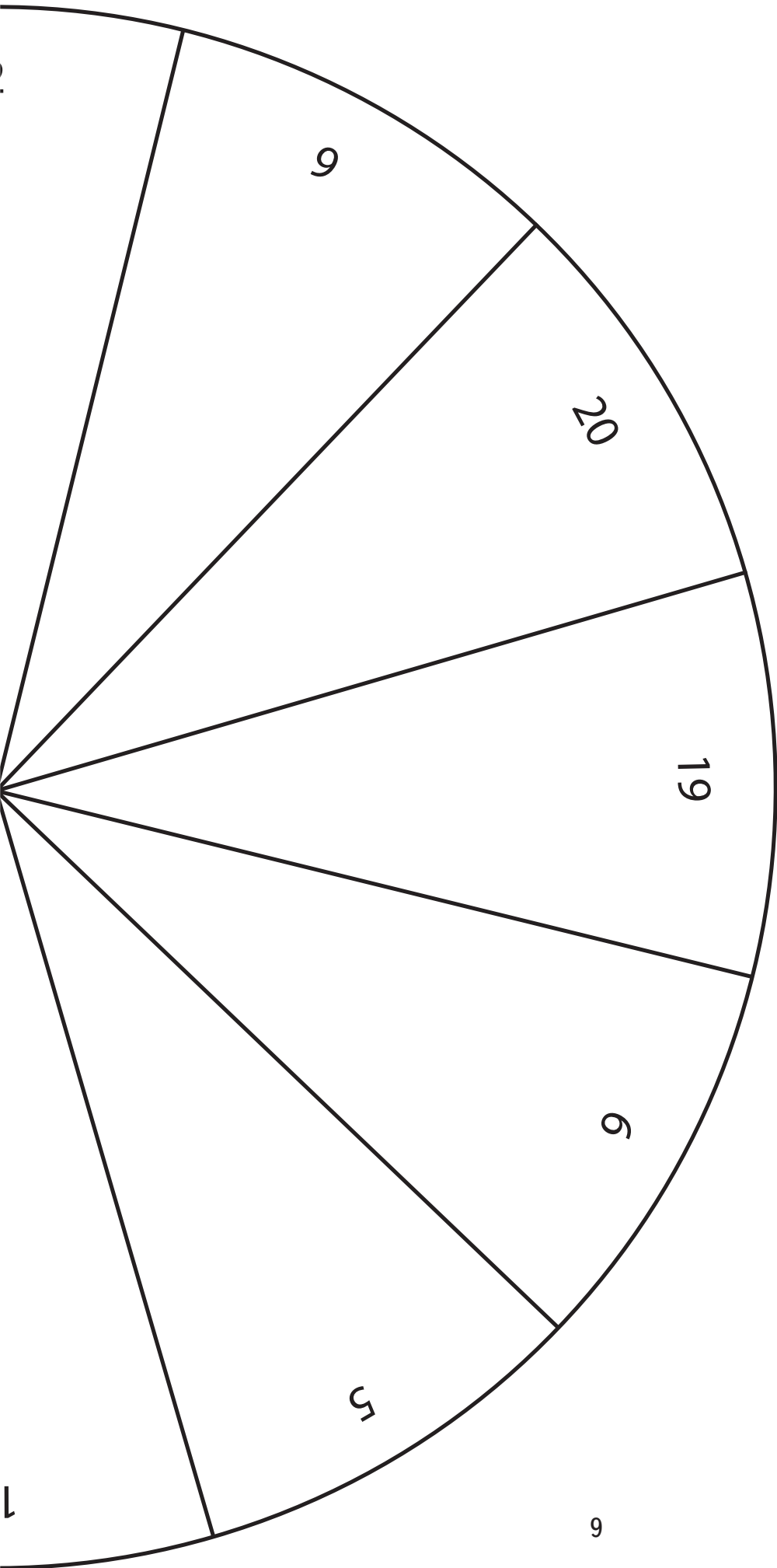

Приложение 48, занятие 29

Задача 3. Сколько трёхбуквенных паролей можно составить, используя каждую из букв А, Б, К и Р не более одного раза в каждом пароле?

Решение

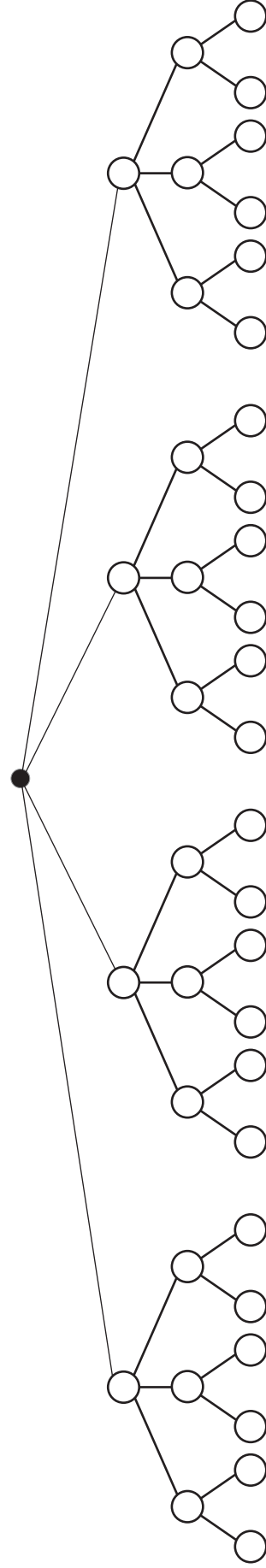

Ответ: _____ паролей.

Задача 2. Сколько трёхзначных кодов можно составить с помощью цифр 7, 8, 9 и 0, если известно, что в одном коде нельзя использовать одинаковые цифры?

Решение

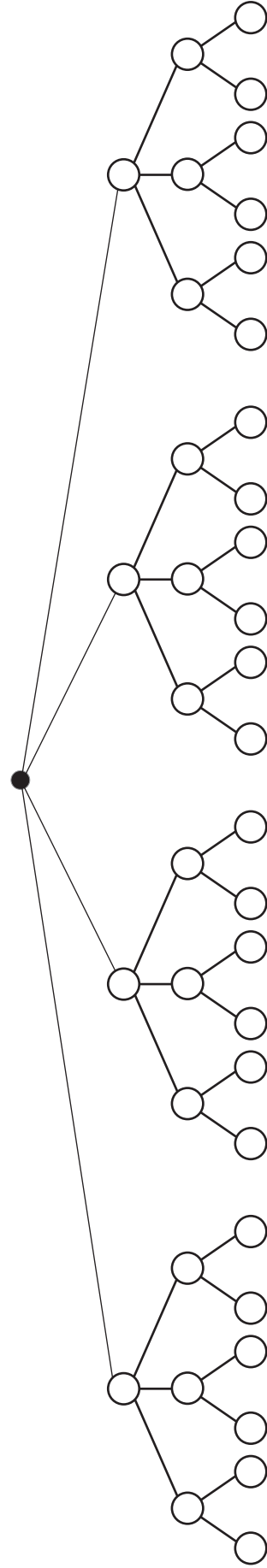

Ответ: _____ кодов.

И + (4 · 25) + РИЯ

(27 : 9) + ТОН

(5 · 8) + ОНОЖКА

С + (IX – VI) + Ж

(81 – 78) + БУНА

ПРО + (54 + 46) + Й

(II + IV + I) + Я

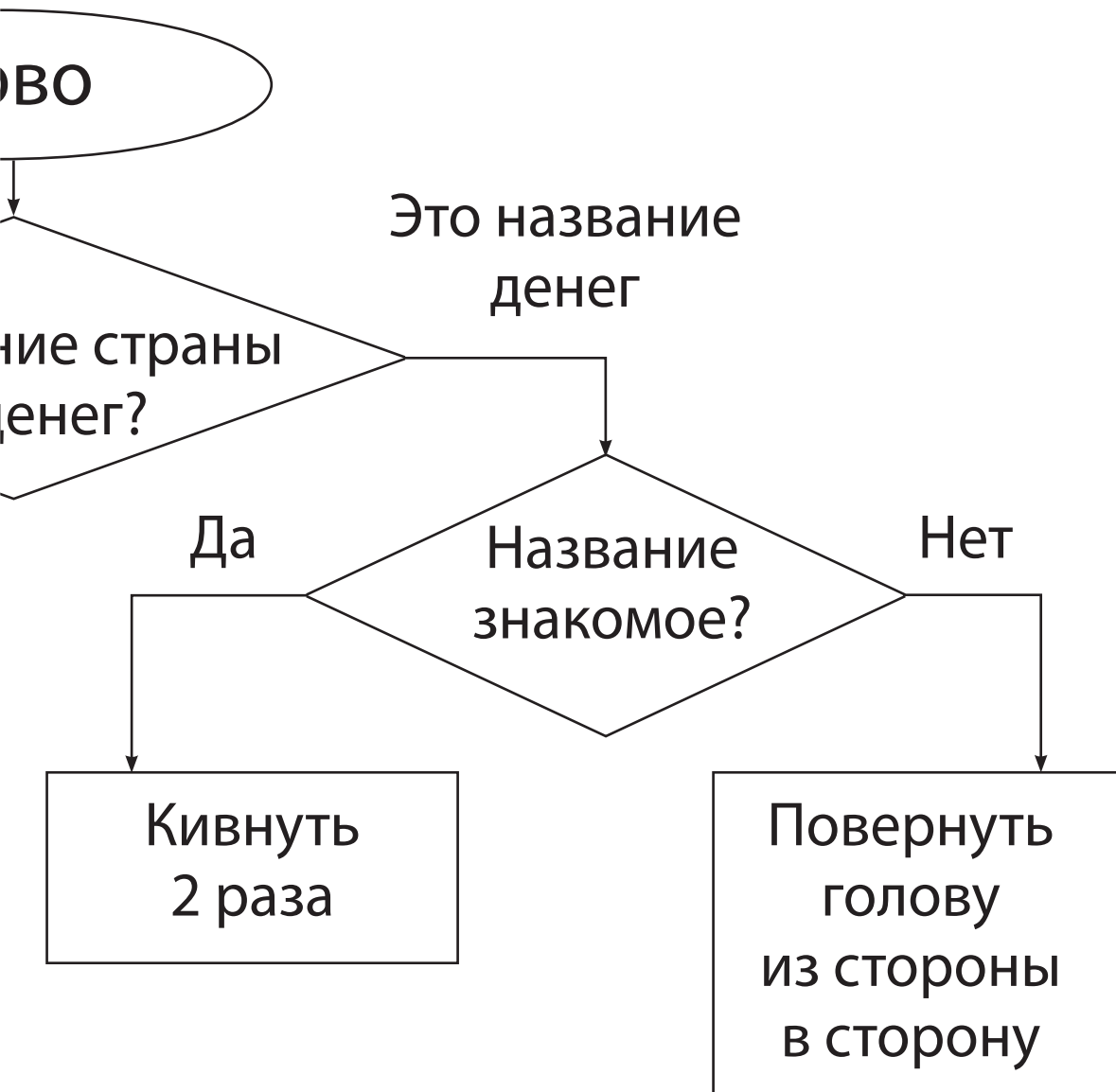

Приложение 45, занятие 27

,	ВО	,	ША
ГО	РА	ШИФ	ЛОМ
РЫ	КИ	ЛО	ДЫ

Приложение 44, занятие 25

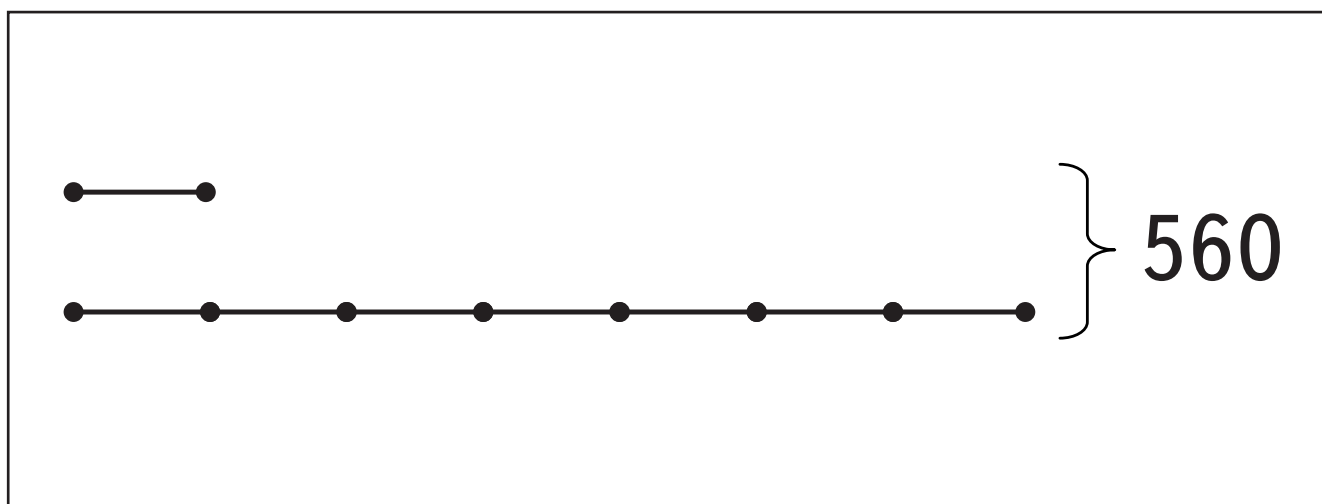
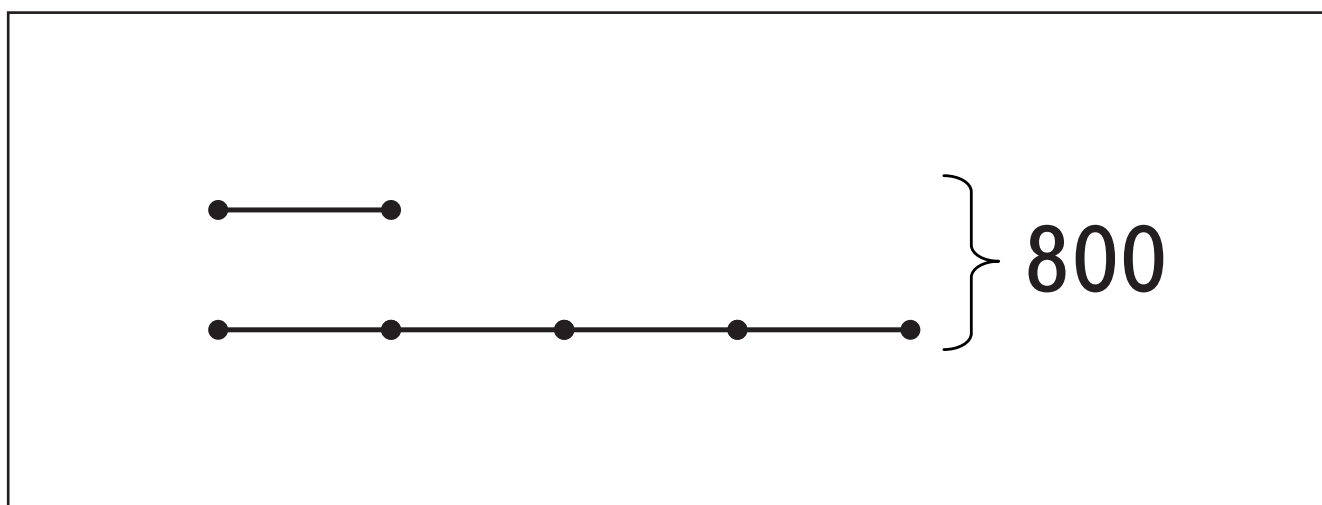
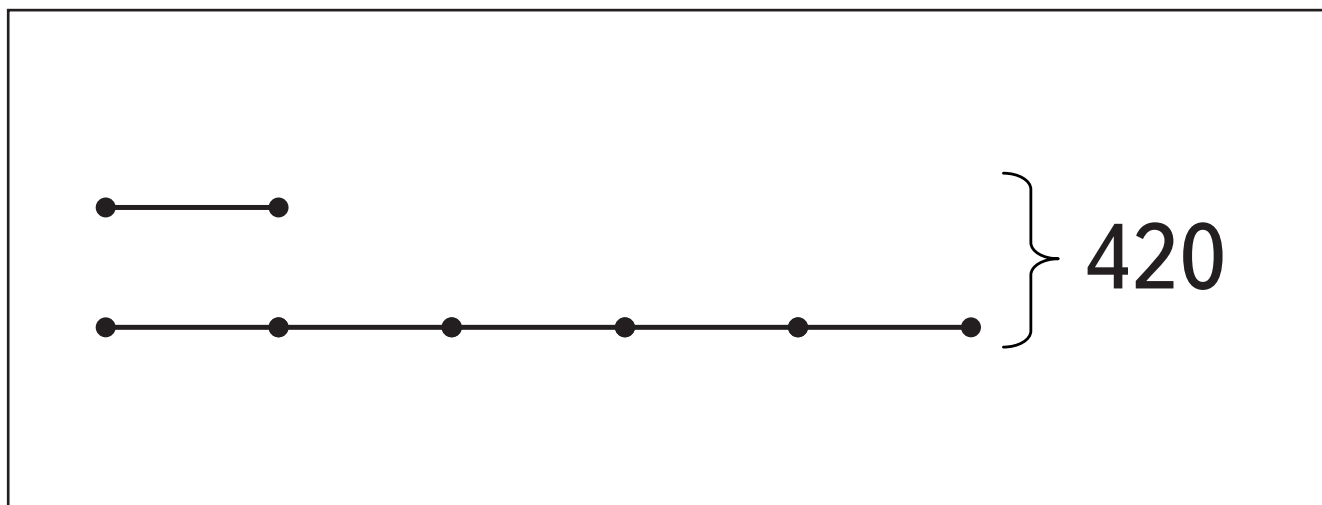

Приложение 42, занятие 24

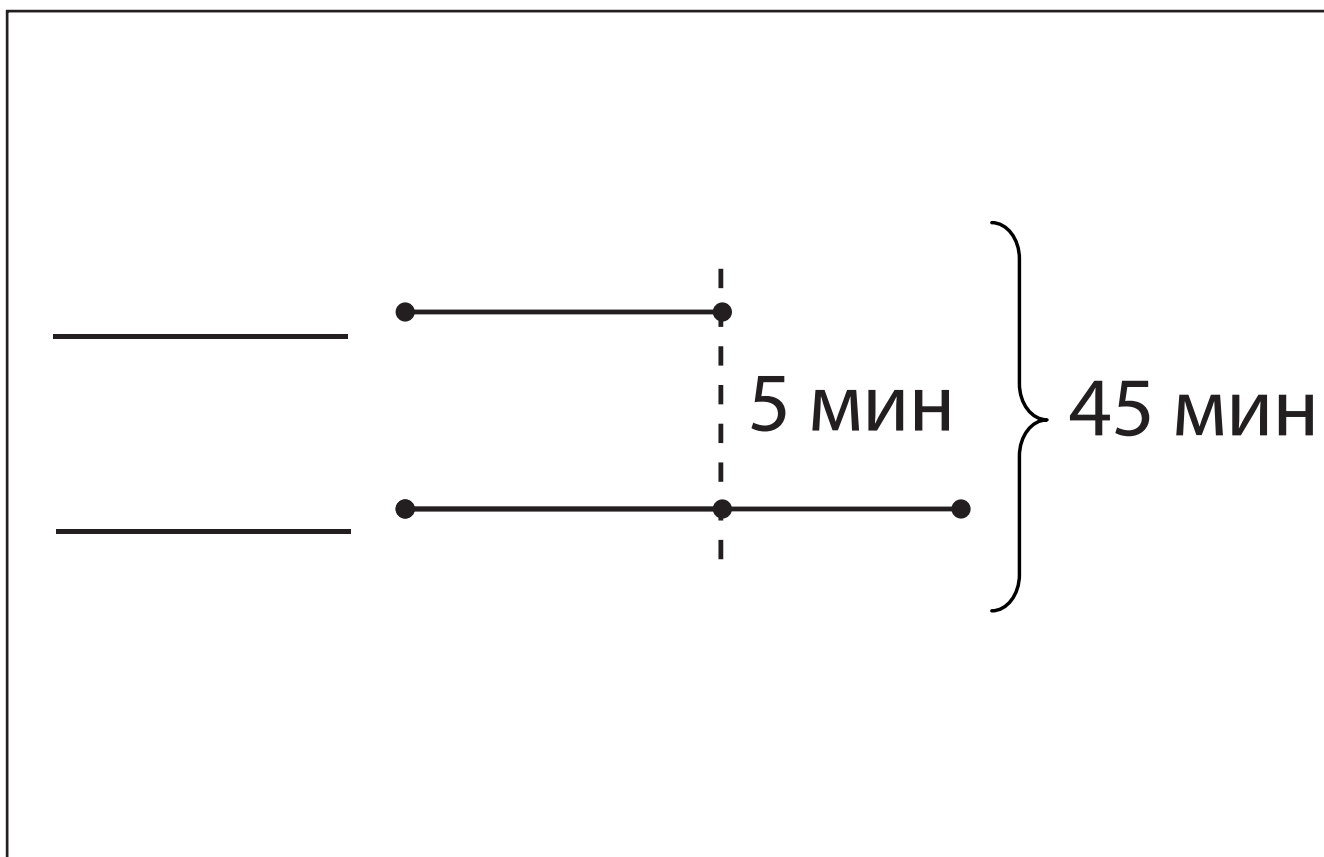
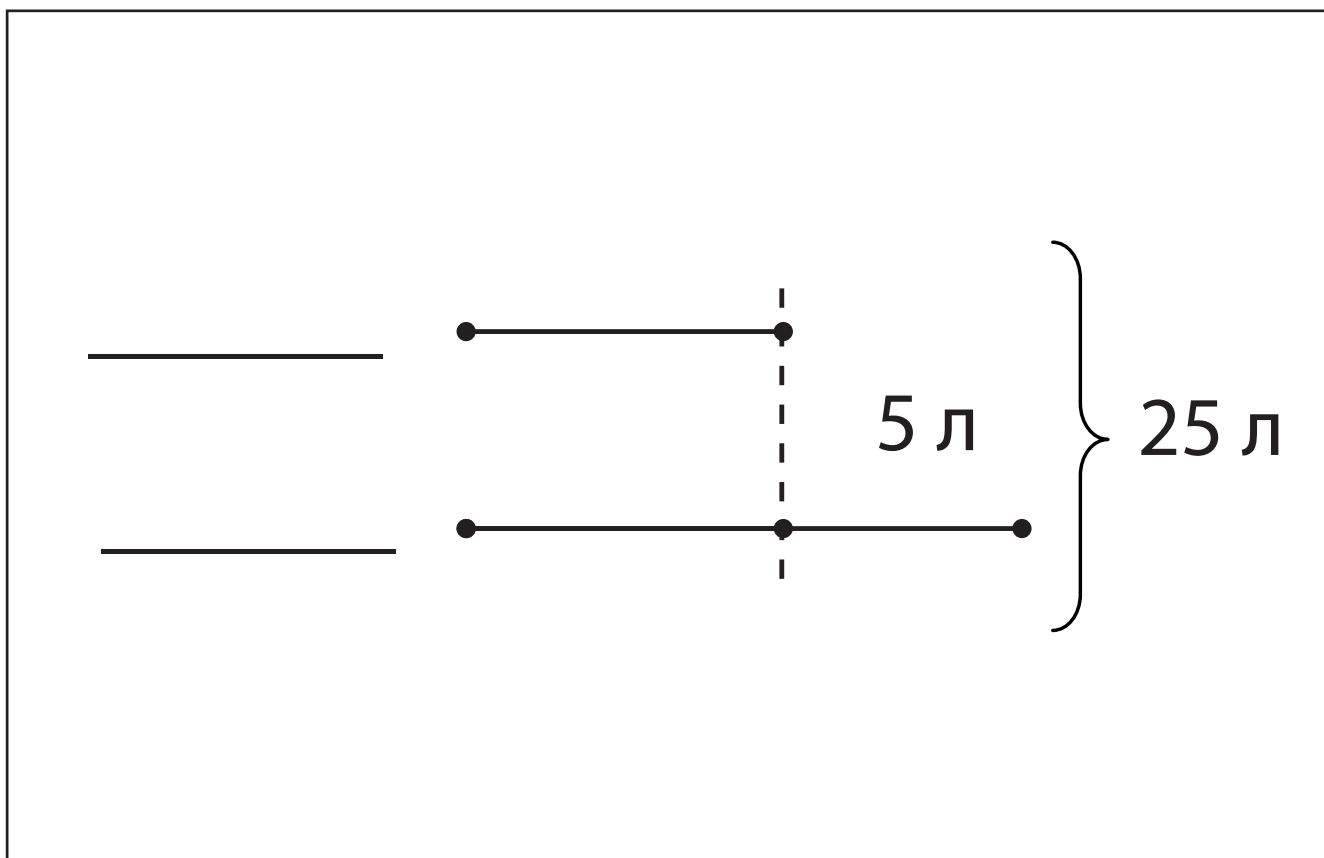

Приложение 39, занятие 23

The image shows a worksheet for a cutting activity. It consists of a large rectangular frame divided into four quadrants by a horizontal and a vertical dashed line. Each quadrant contains a diagram of a curved line with dots. The top-left and bottom quadrants have a question mark below the diagram. The top-right quadrant has a partial diagram. Scissors icons are placed at the ends of the dashed lines to indicate where to cut.

Приложение 38, занятие 23

?

24

?

35 кг

Приложение 42, занятие 24

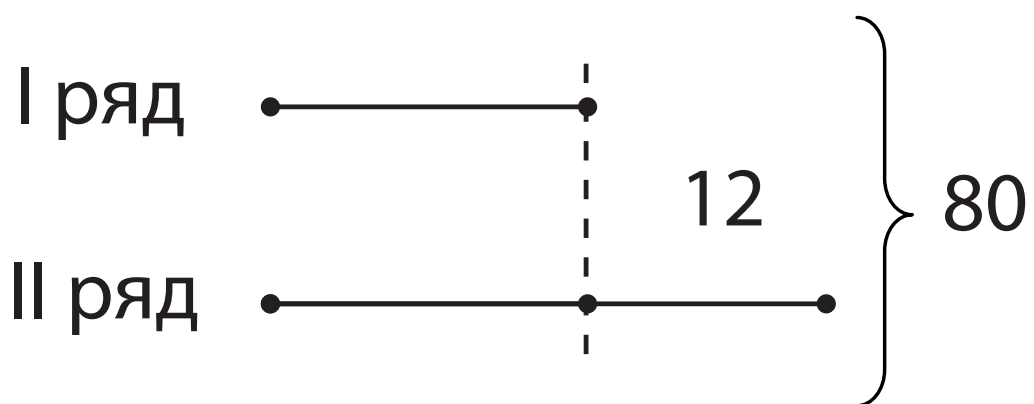
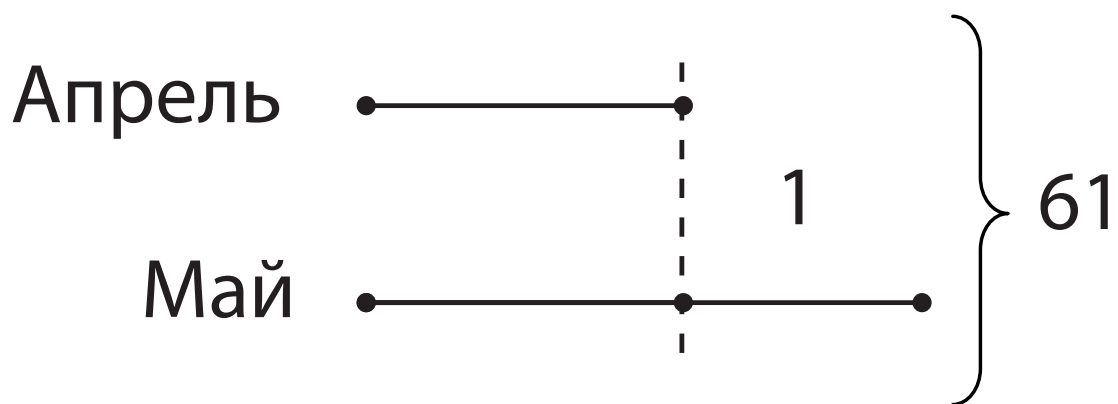

БЕЛЫЙ КРАСНЫЙ

ЗЕЛЁНЫЙ БЕЛЫЙ

КРАСНЫЙ ЗЕЛЁНЫЙ

БЕЛЫЙ КРАСНЫЙ

ЗЕЛЁНЫЙ БЕЛЫЙ

КРАСНЫЙ БЕЛЫЙ

СКОРОСТЬ
ВРЕМЯ
РАССТОЯНИЕ

Приложение 33, занятие 17



Приложение 40, занятие 24

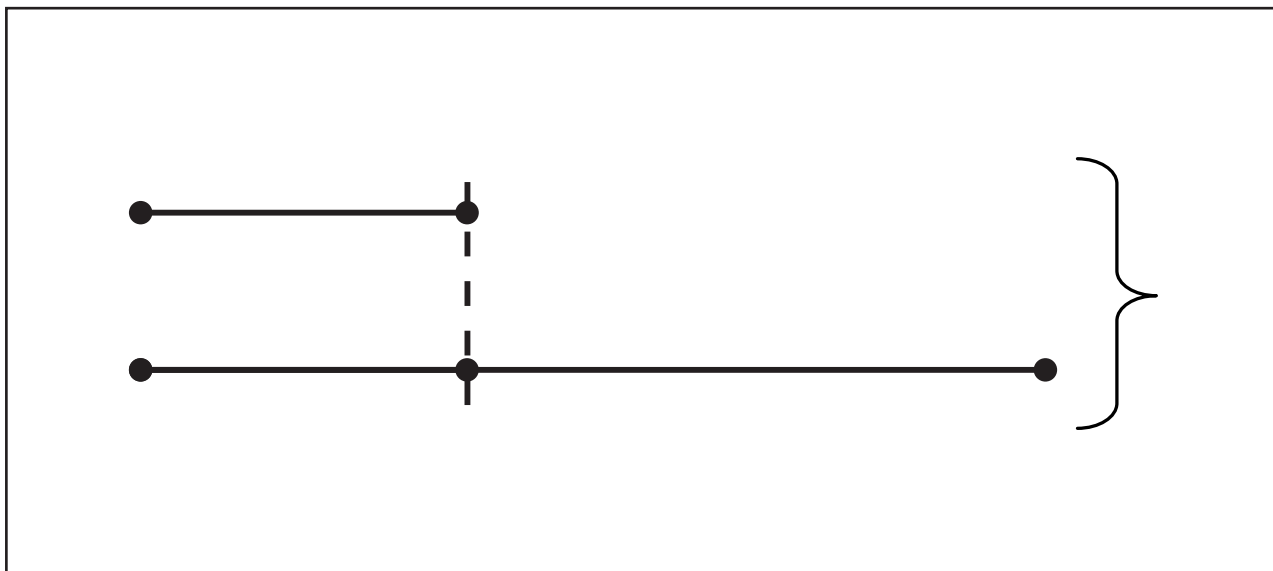

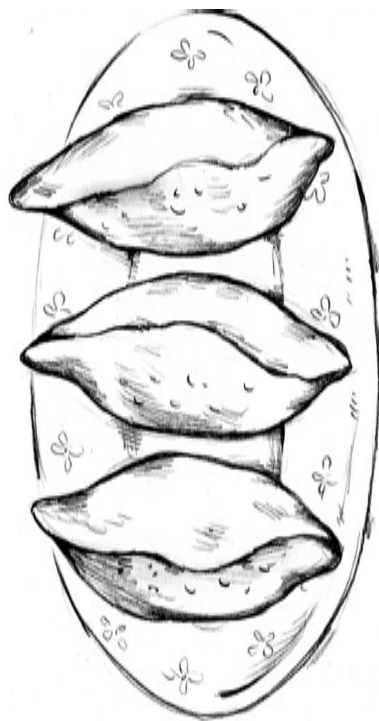
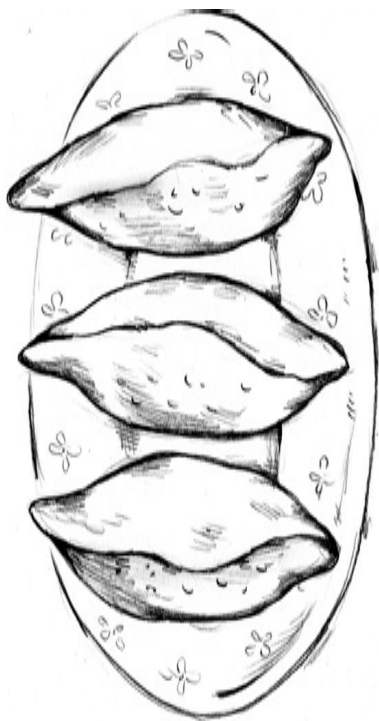
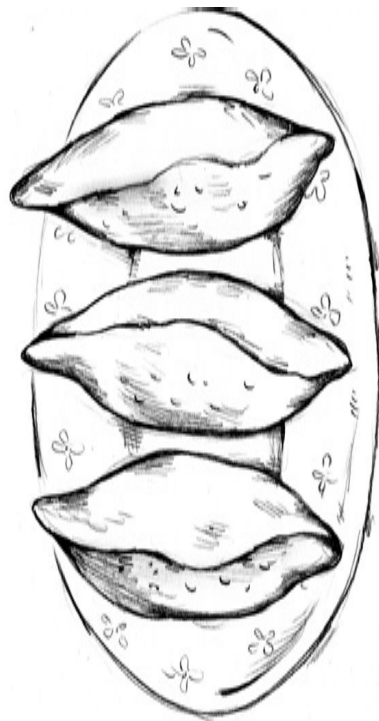
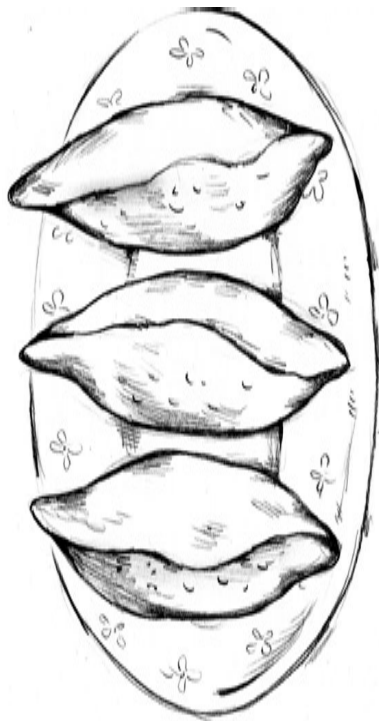

Приложение 23, занятие 9

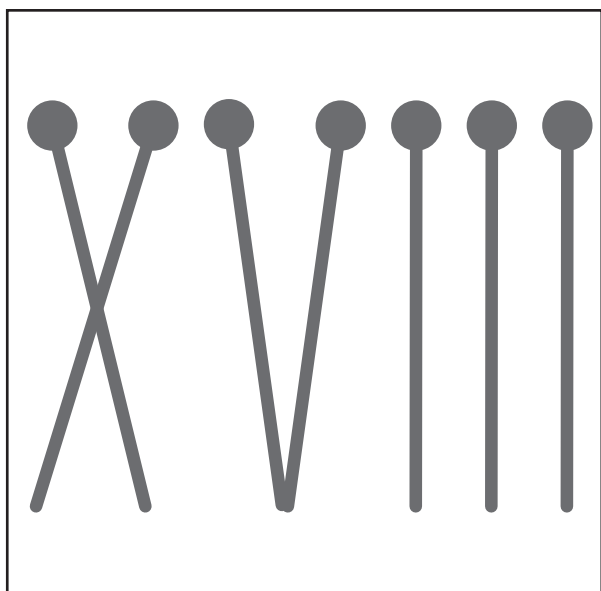
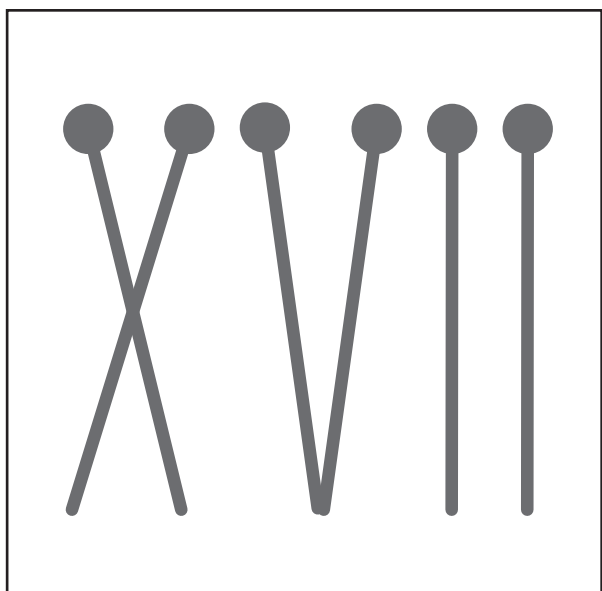
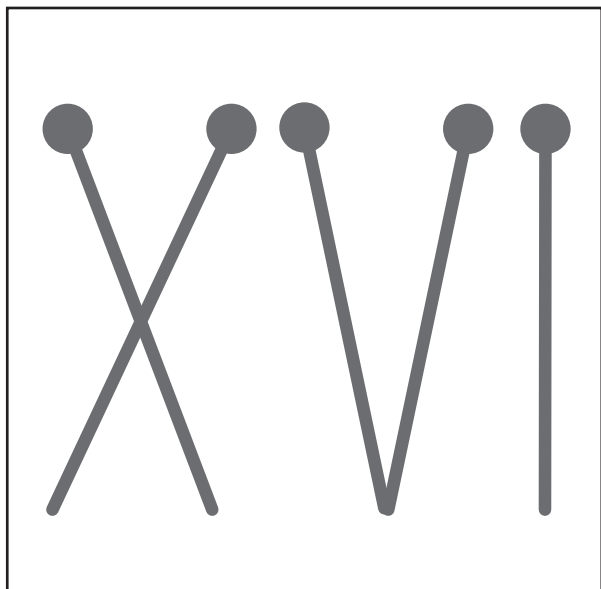
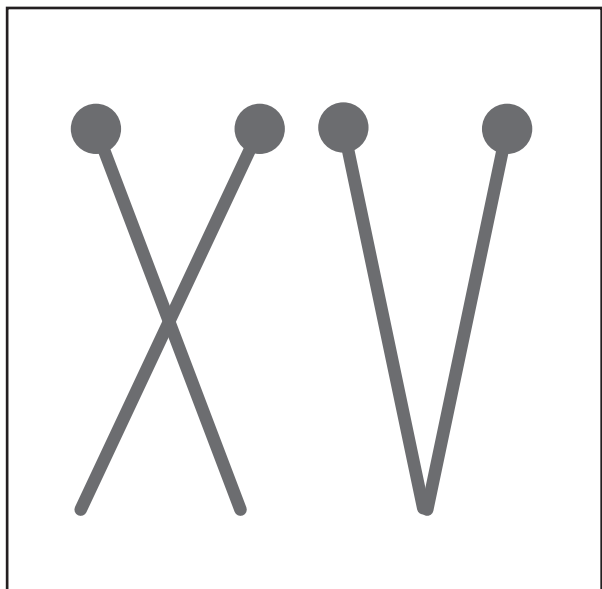

Приложение 26, занятие 12

$$90 : 18$$
$$96 : 3$$

Приложение 23, занятие 9

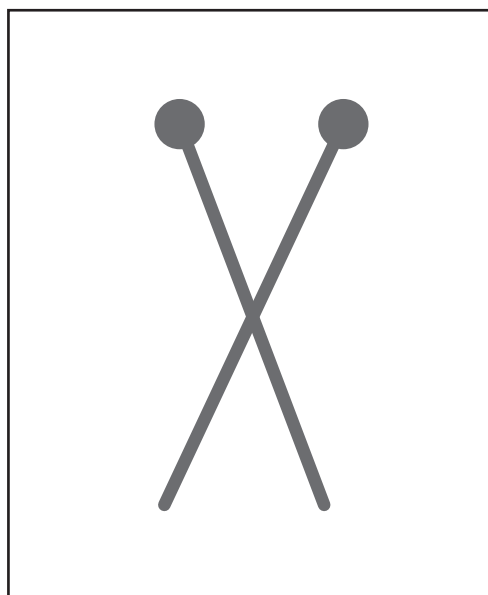
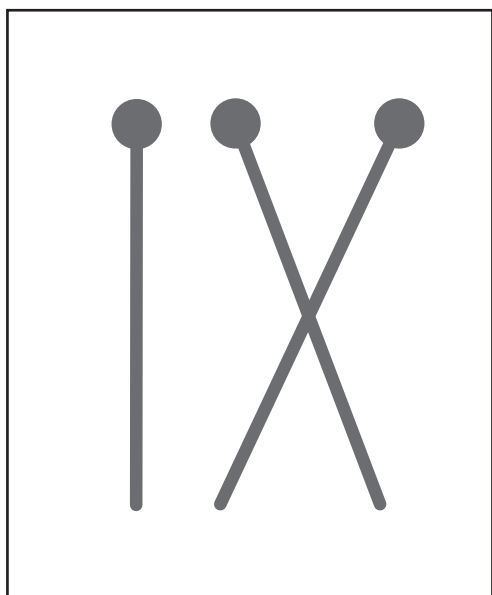
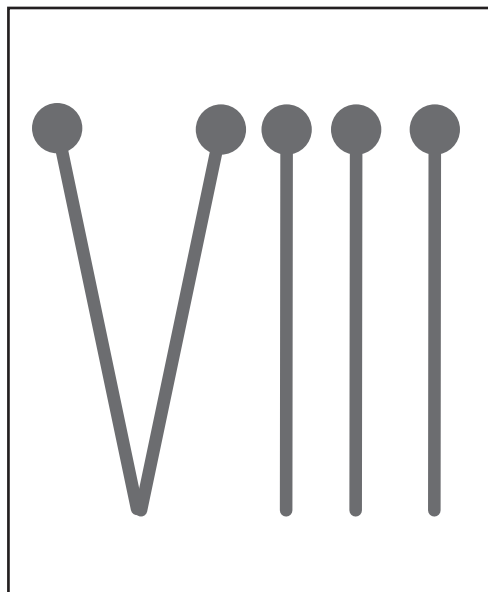
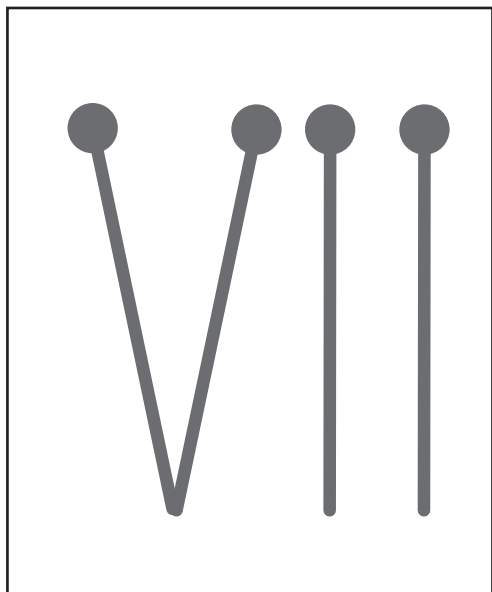

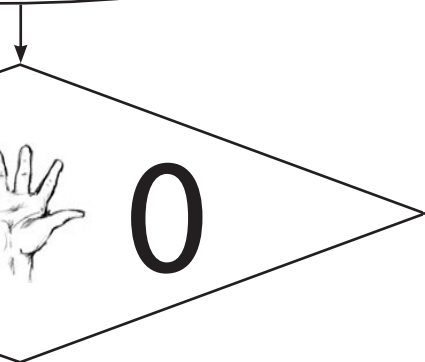

да

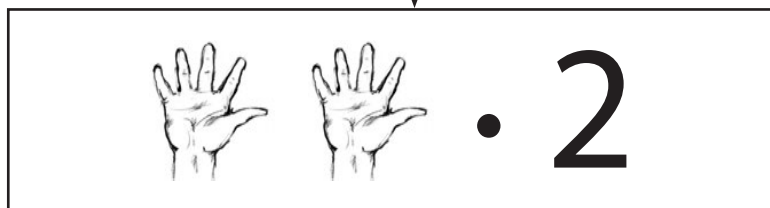
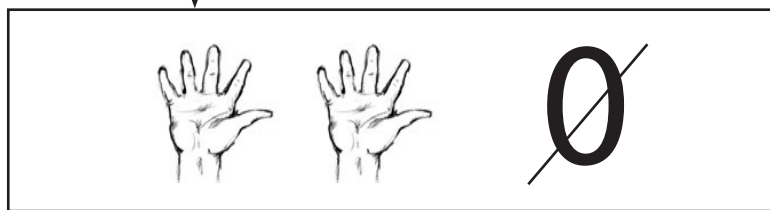



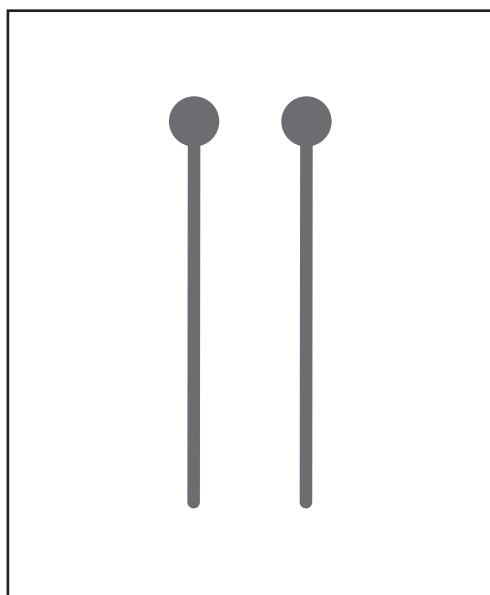
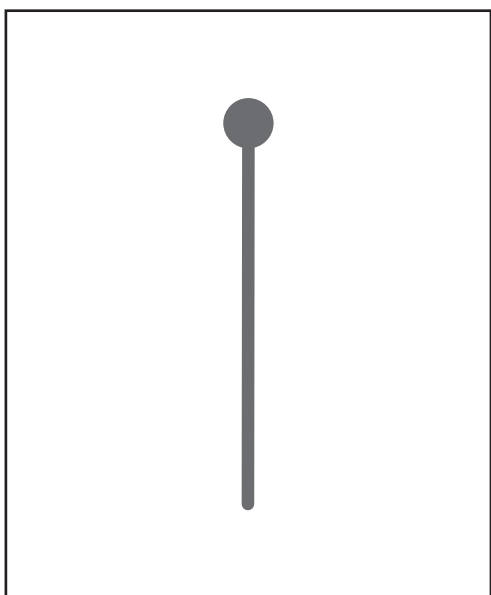
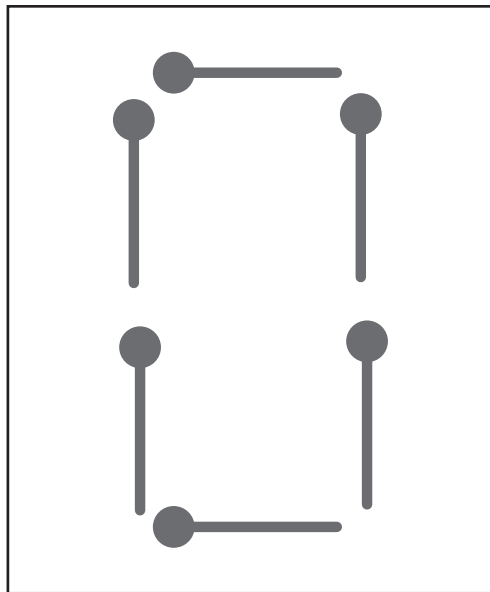
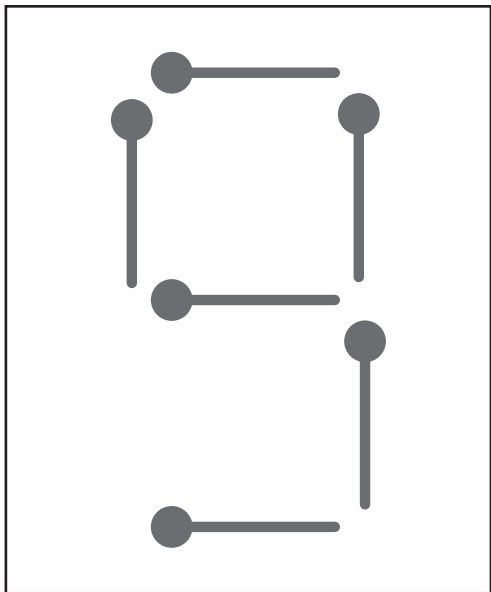

вет:

Приложение 23, занятие 9



Приложение 27, занятие 12

		0
		2
		4 : 2
		6
		8

Приложение 23, занятие 9

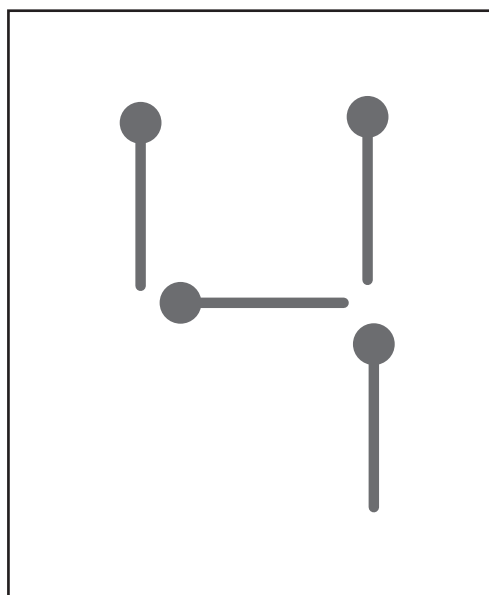
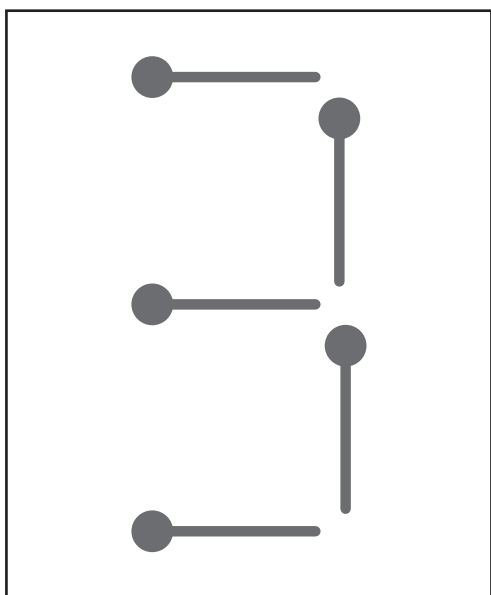
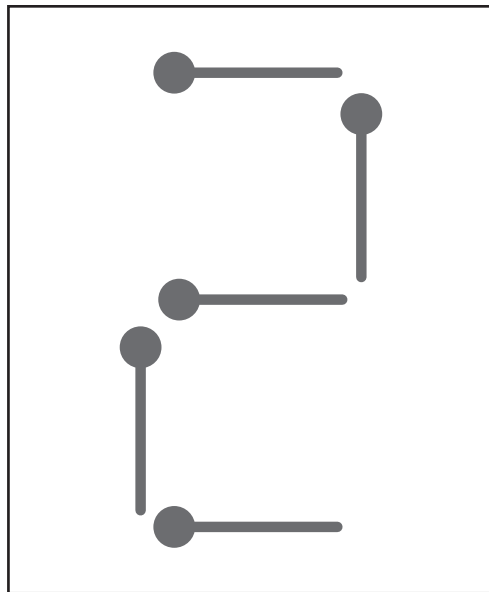
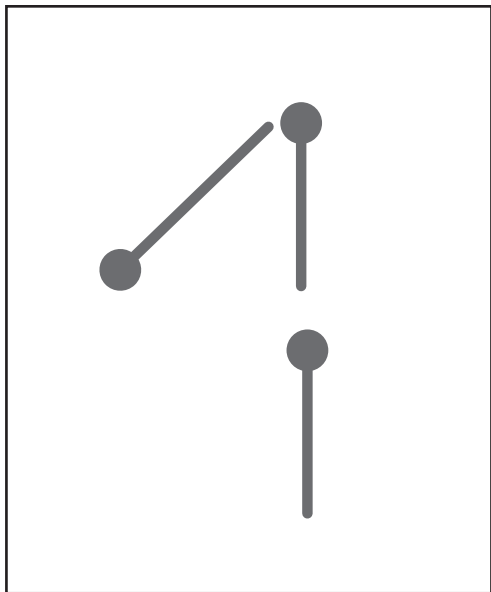

Приложение 26, занятие 12

$$75 : 5$$

$$45 : 15$$

$$72 : 6$$

$$68 : 2$$

Приложение 22, занятие 8

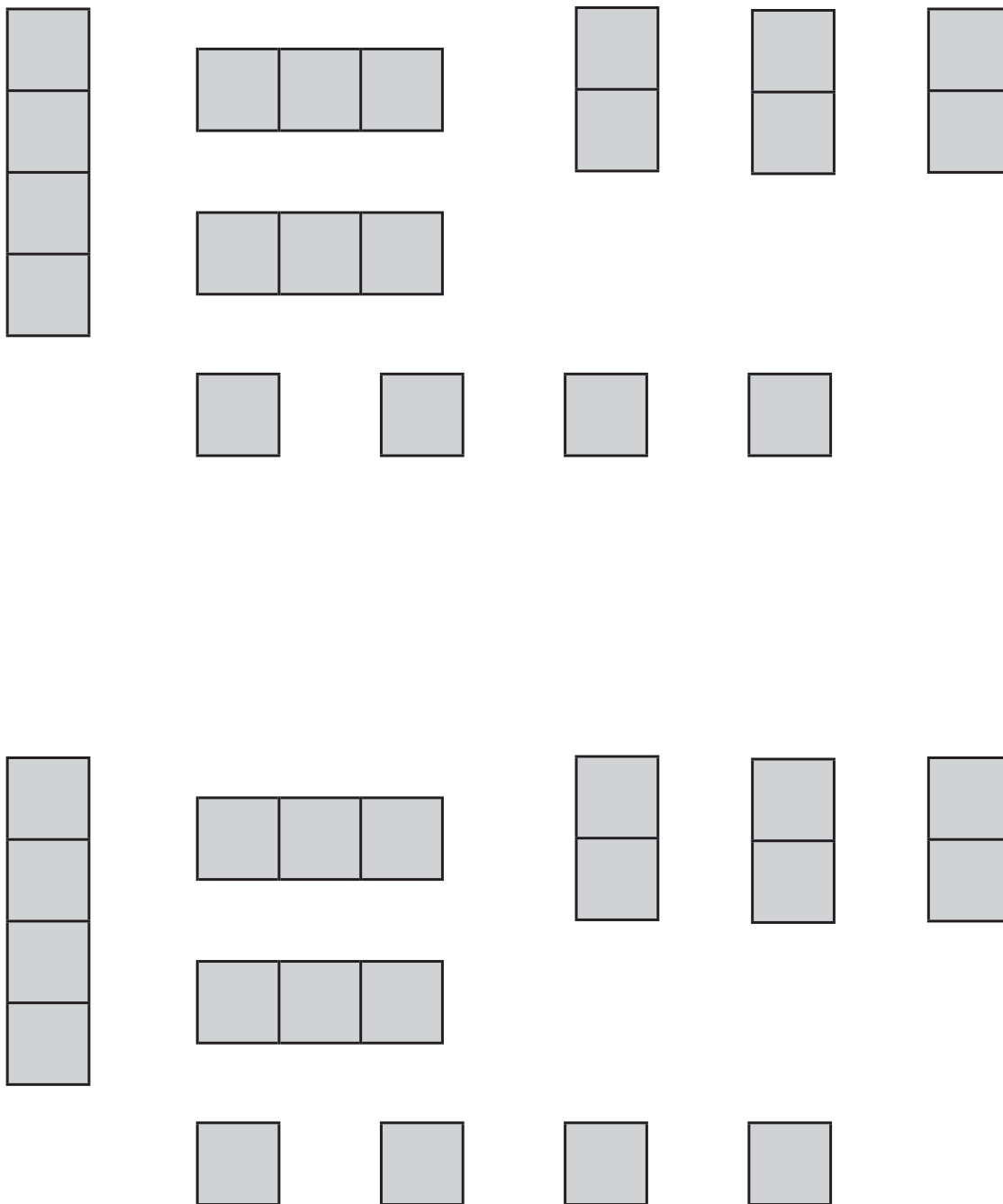

Приложение 30, занятие 15

$$\text{snowflake} - \text{snowflake} \cdot \text{snowflake} : \text{snowflake}$$

$$\text{snowflake} \cdot (\text{snowflake} - \text{snowflake}) : \text{snowflake} + \text{snowflake}$$

$$\text{snowflake} + \text{snowflake} : (\text{snowflake} - \text{snowflake}) \cdot \text{snowflake}$$

$$\text{snowflake} : \text{snowflake} \cdot \text{snowflake} - (\text{snowflake} + \text{snowflake})$$

$$\text{snowflake} - (\text{snowflake} : \text{snowflake} + \text{snowflake}) \cdot \text{snowflake}$$

$$\text{snowflake} : \text{snowflake} + (\text{snowflake} - \text{snowflake} \cdot \text{snowflake})$$

Деление «удобных» слагаемых

Приложение 24, занятие 10

	-	
	=	:
+	.	

		+
.		
=	-	:



.		
+	=	+
	-	:

	+	.
:	:	=
	-	



Последовательное деление

Приложение 21, занятие 8

	а	б	в	г	д	е	ж	з	и	к
1										
2										
3										
4										
5										
6										
7										
8										
9										
10										

Приложение 4, занятие 2



Приложение 25, занятие 10

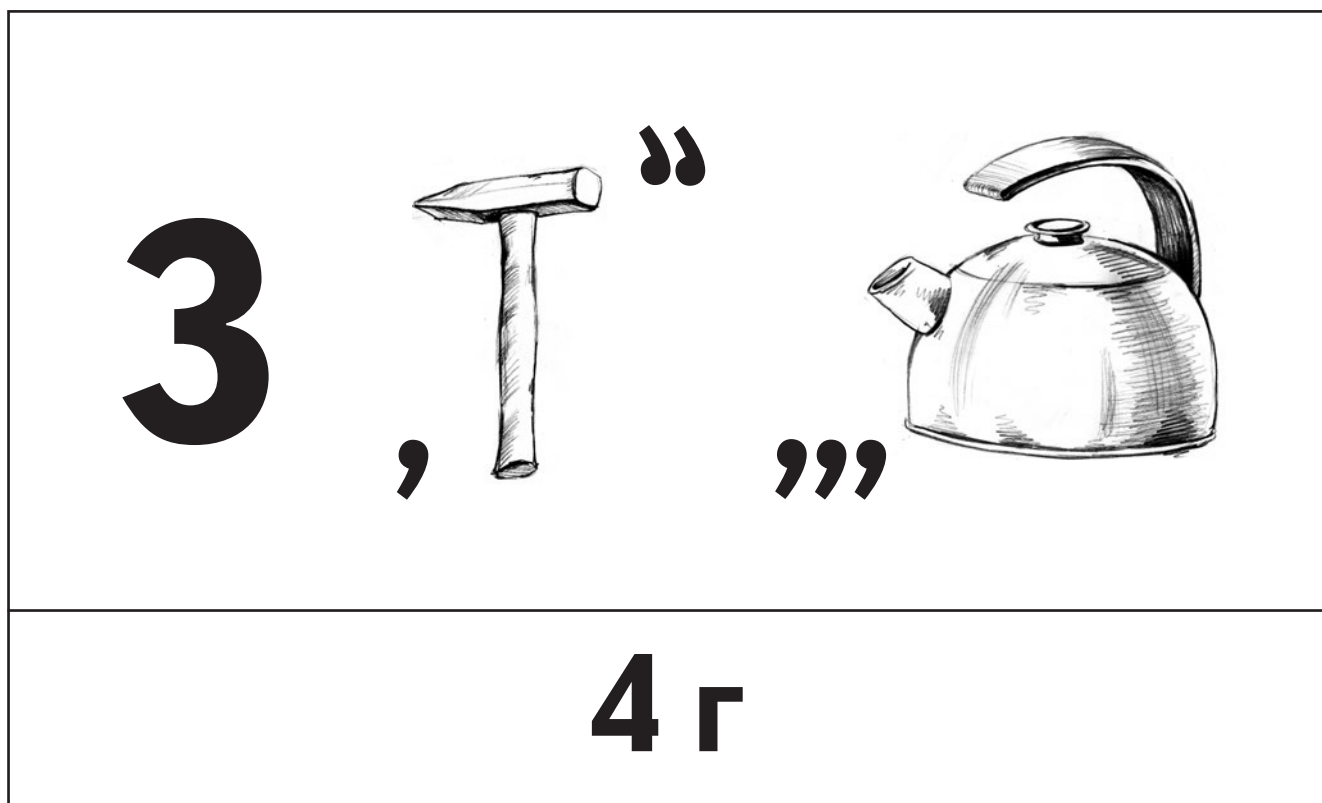

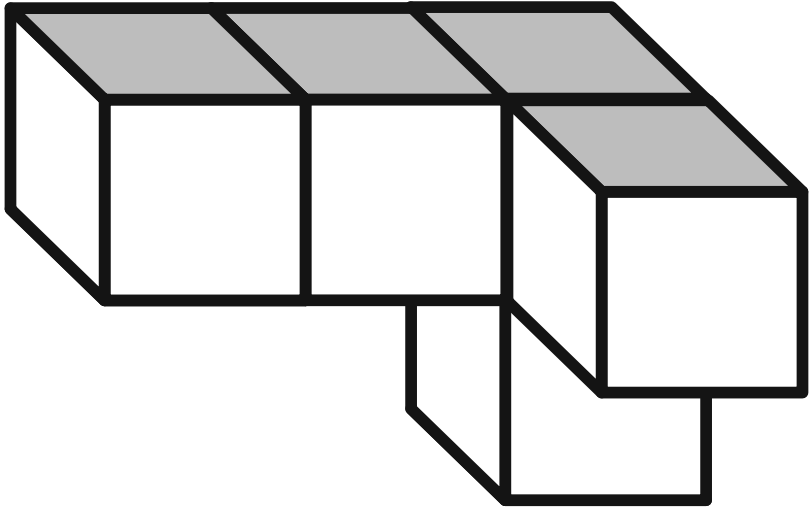

6

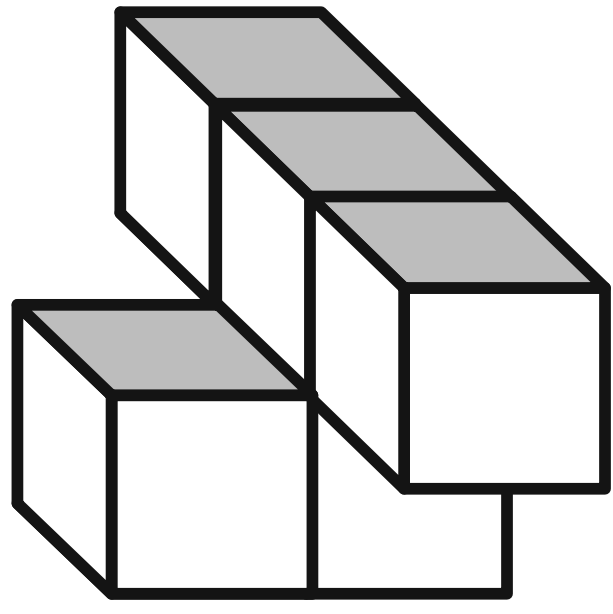

В

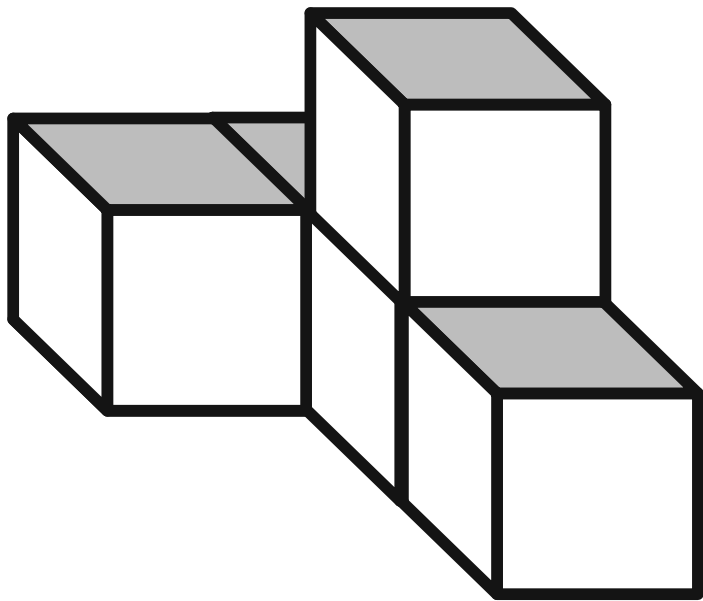

д

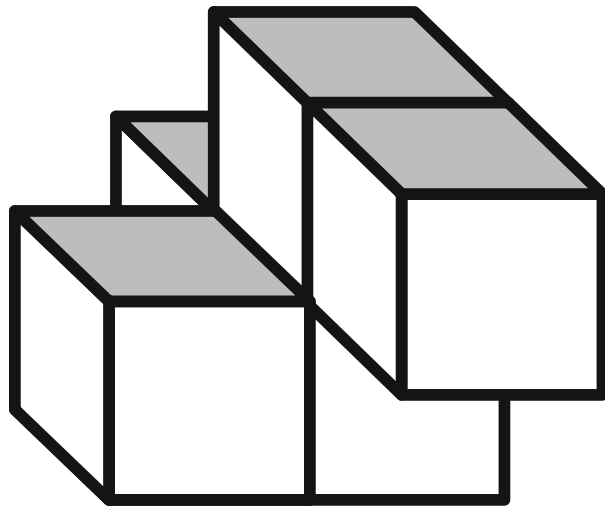

а

Приложение 19, занятие 7

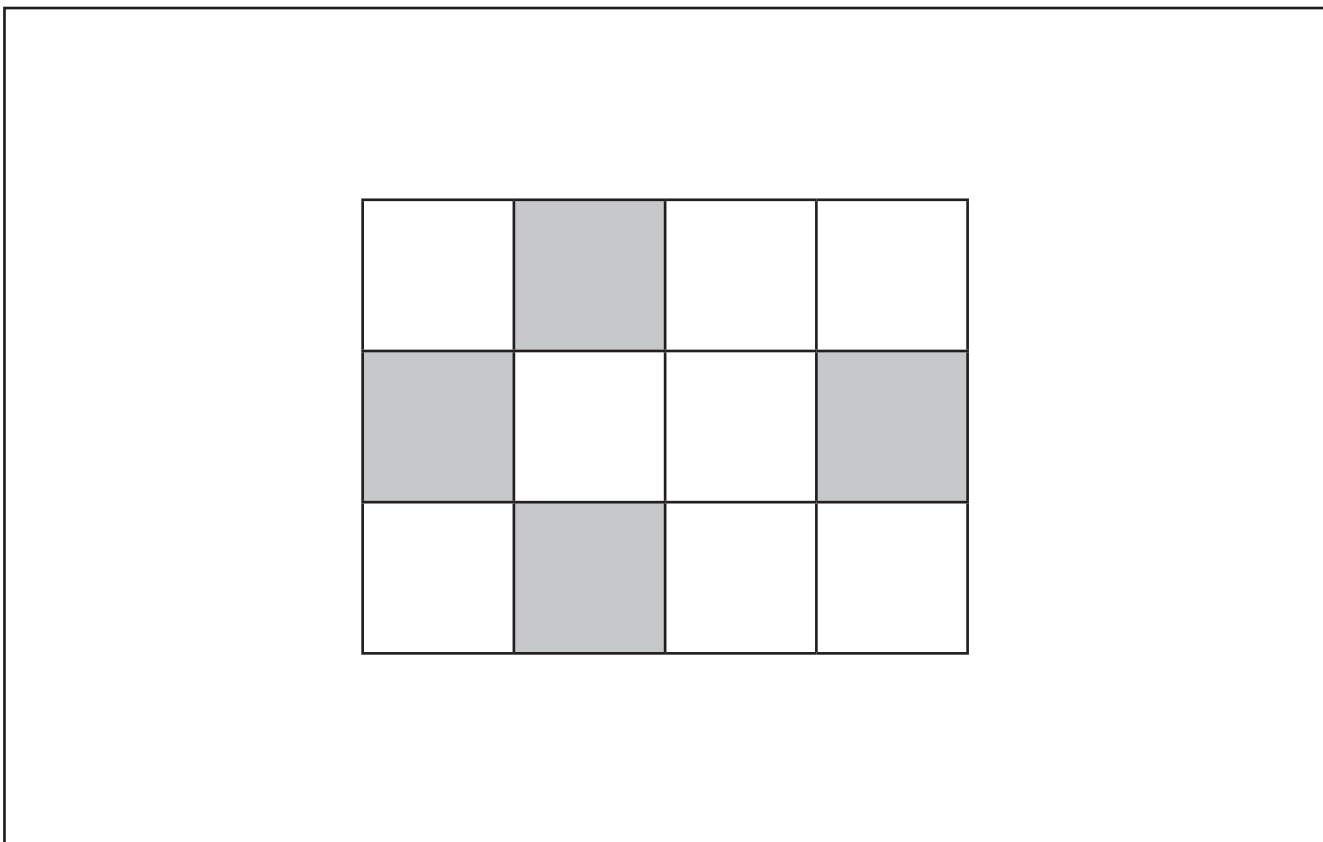
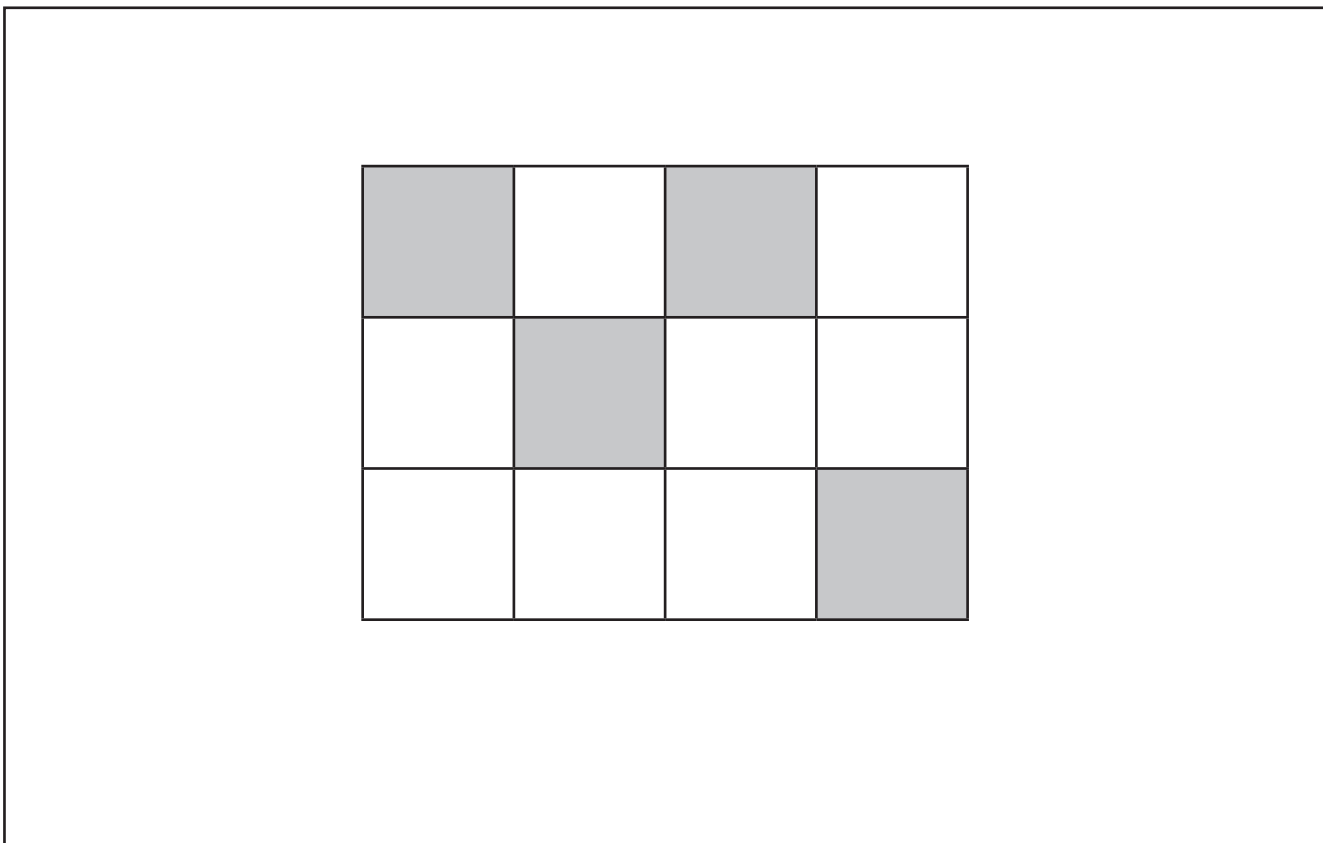

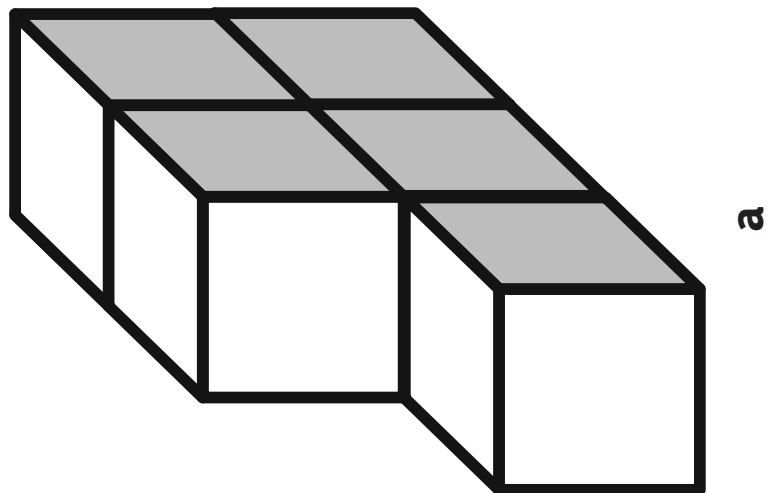
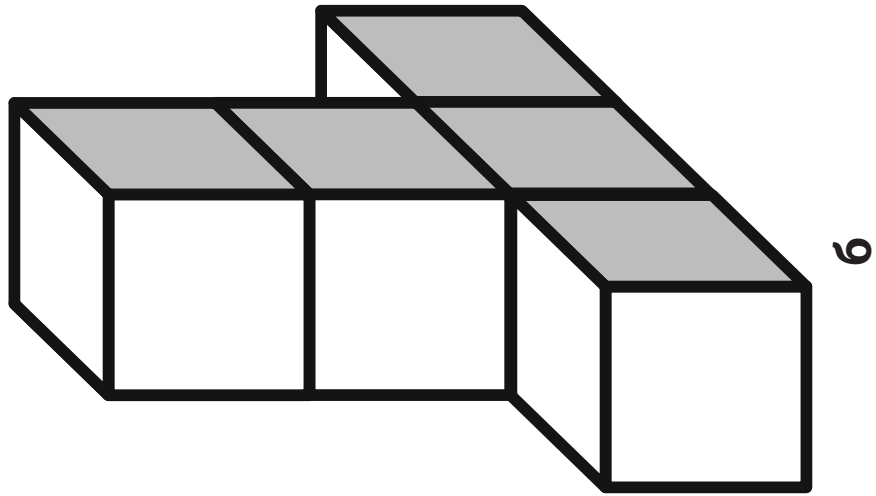

Приложение 19, занятие 7

	■		
		■	
■			■

■		■	
			■
	■		

3

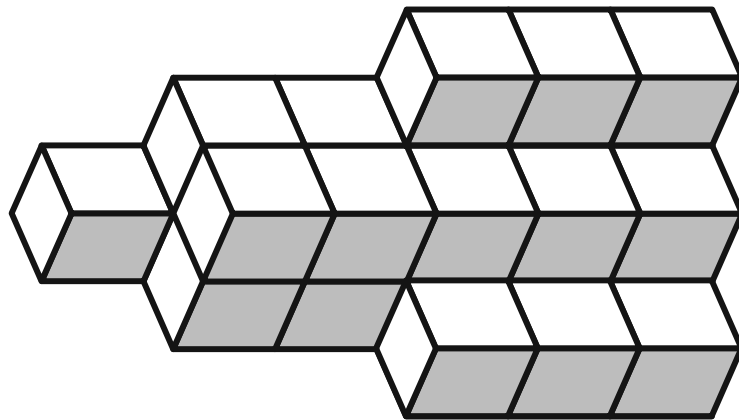

4

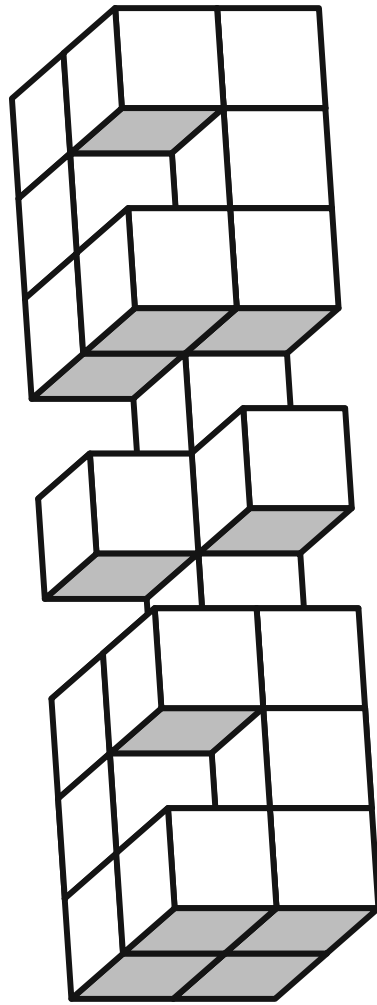

Приложение 14, занятие 5

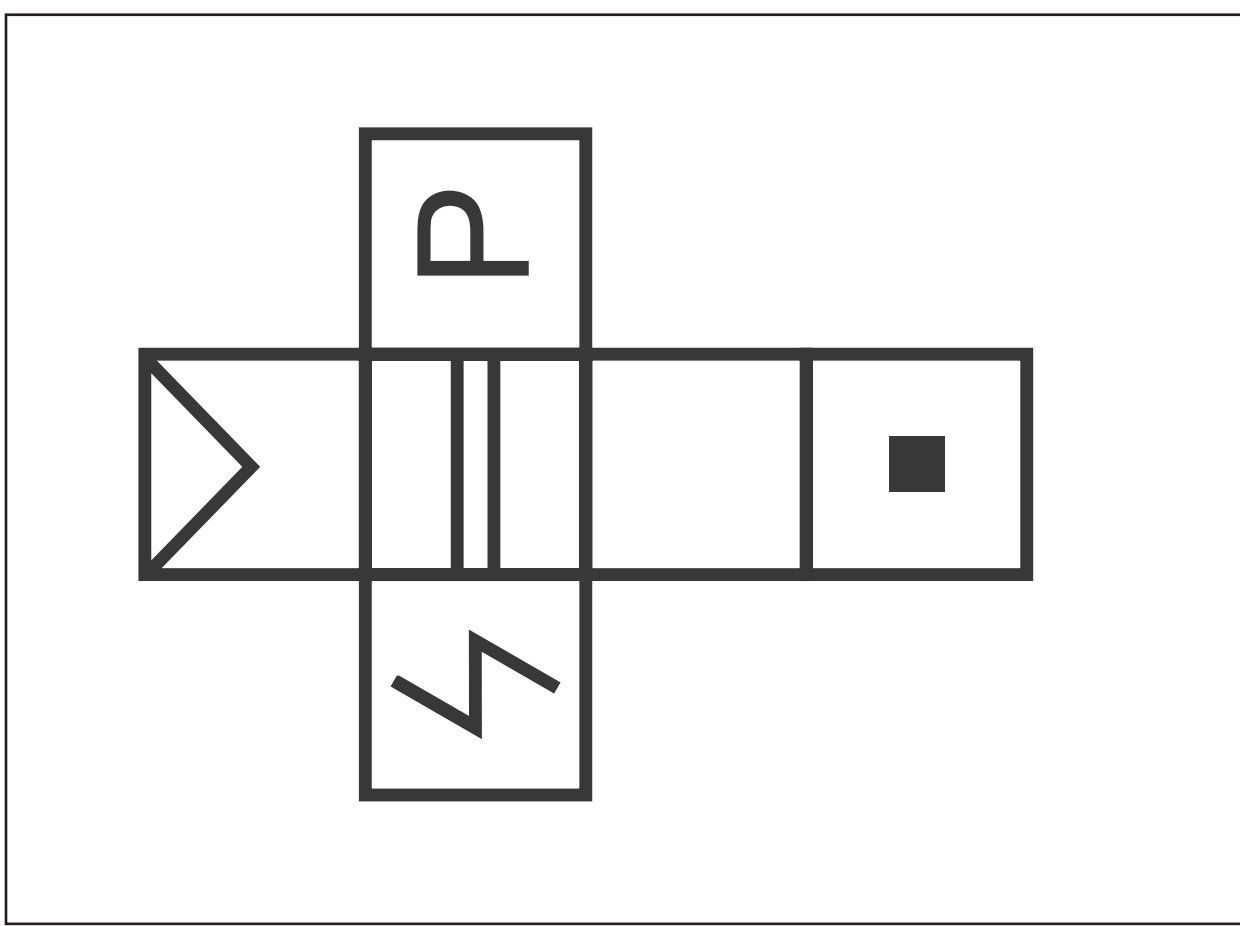
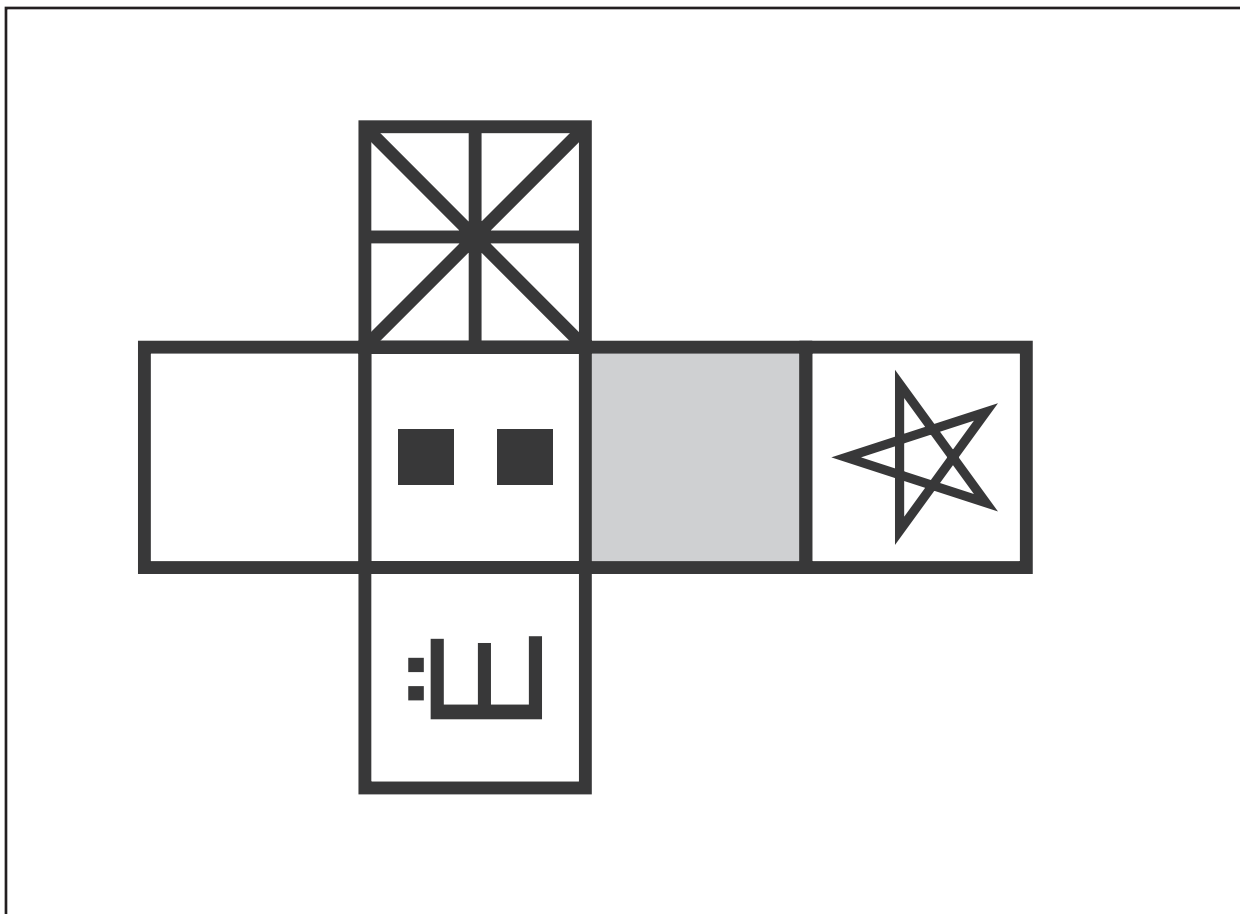

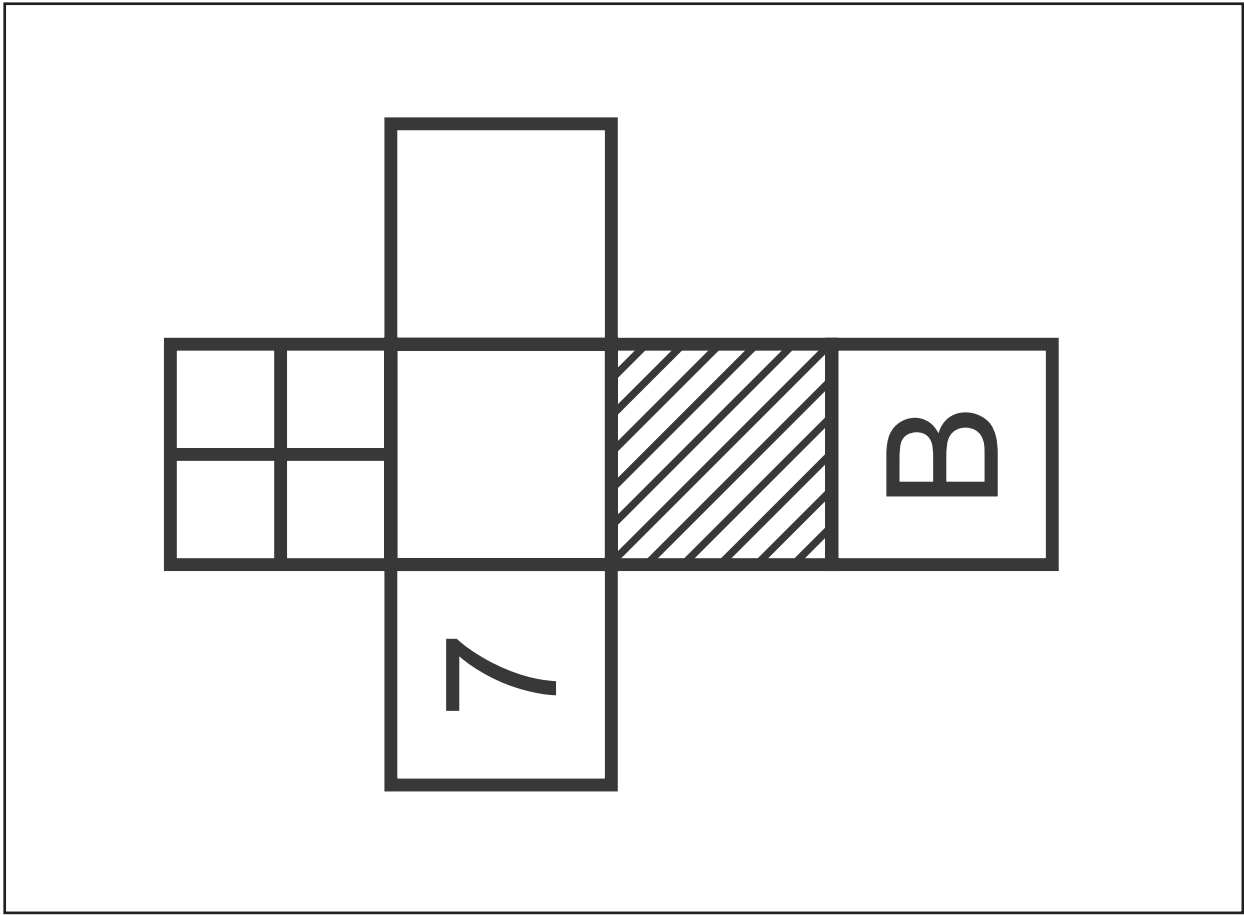
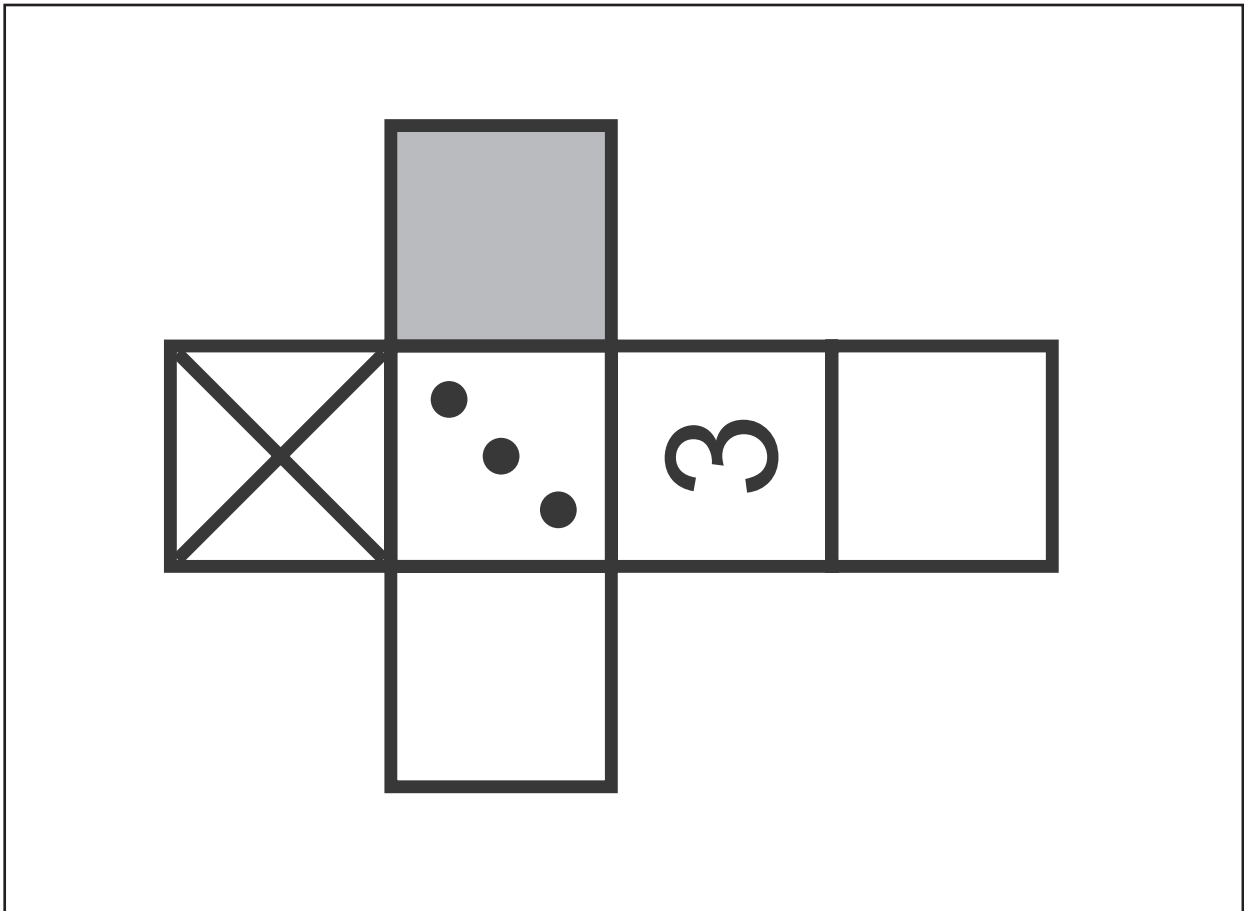

Приложение 12, занятие 4

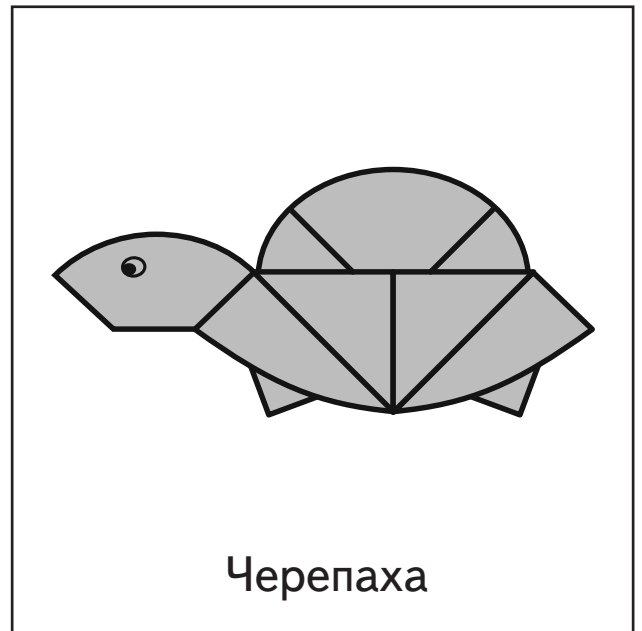
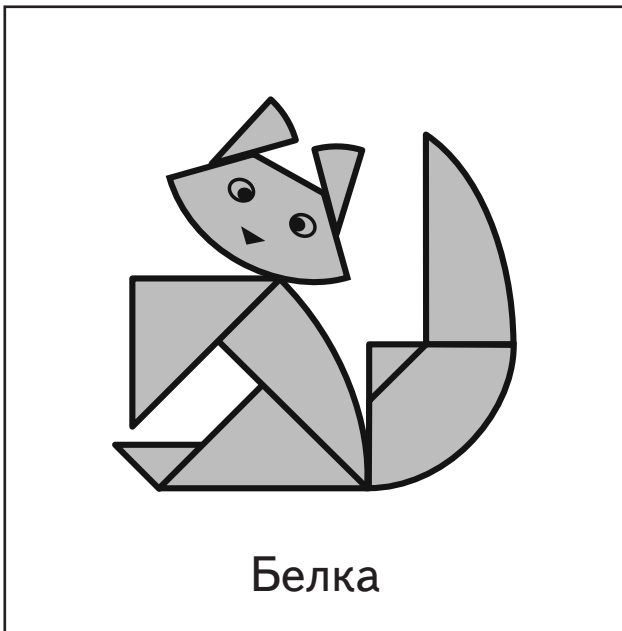
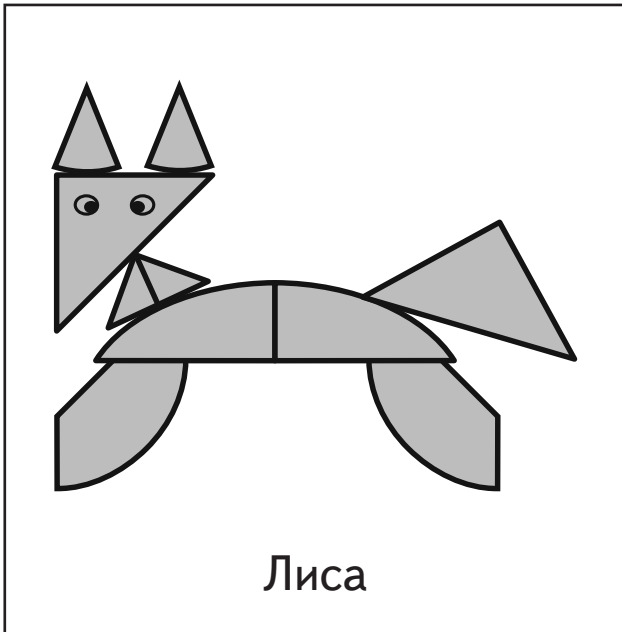

Приложение 12, занятие 4

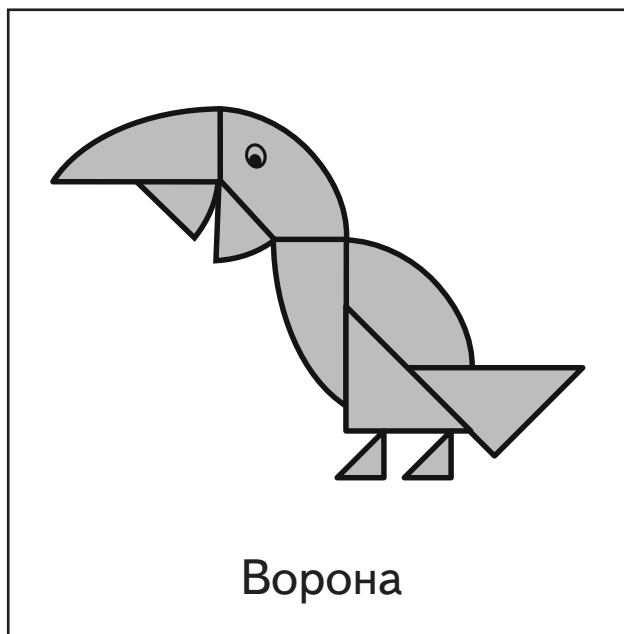
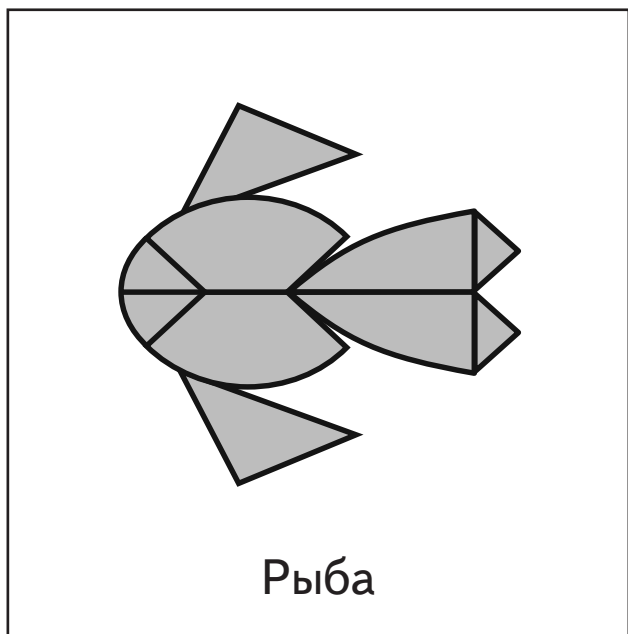
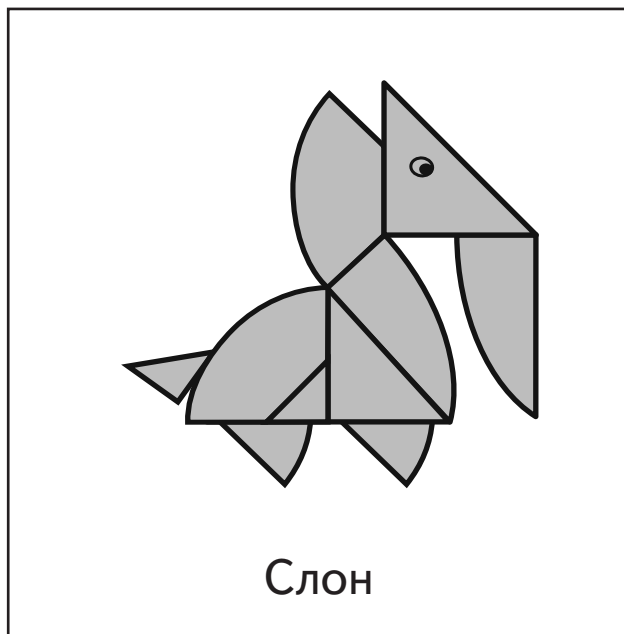
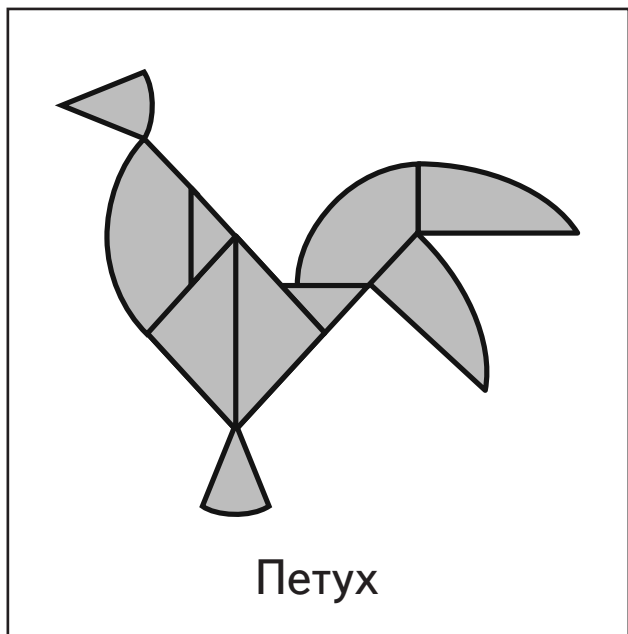

Приложение 8, занятие 3

The image shows two 4x4 grids, each containing a path of black lines. The first grid, labeled '9', has a path that starts at the bottom-left corner, moves right, then up, then right, then up, then right, then up, then right, and finally up to the top-right corner. The second grid, labeled '10', has a path that starts at the bottom-left corner, moves right, then up, then right, then up, then right, then up, then right, then up, then right, and finally up to the top-right corner.

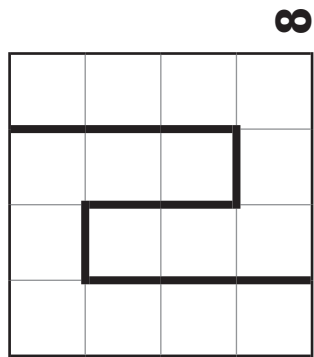
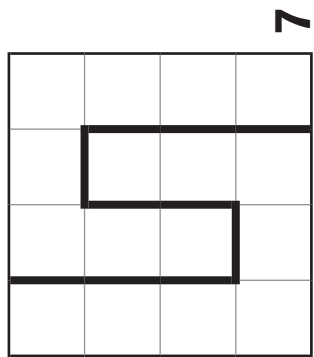
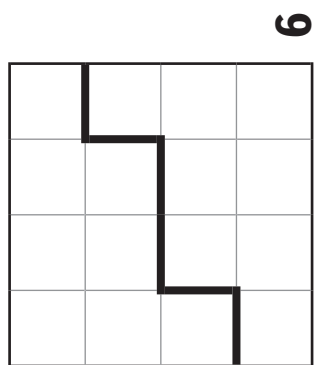
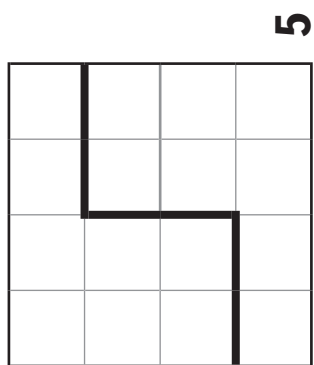

Приложение 7, занятие 3

И

И

З

?

9

Приложение 13, занятие 5

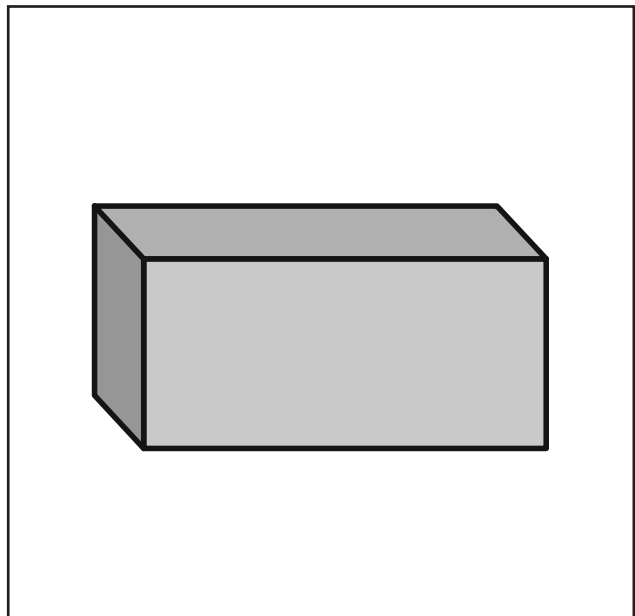
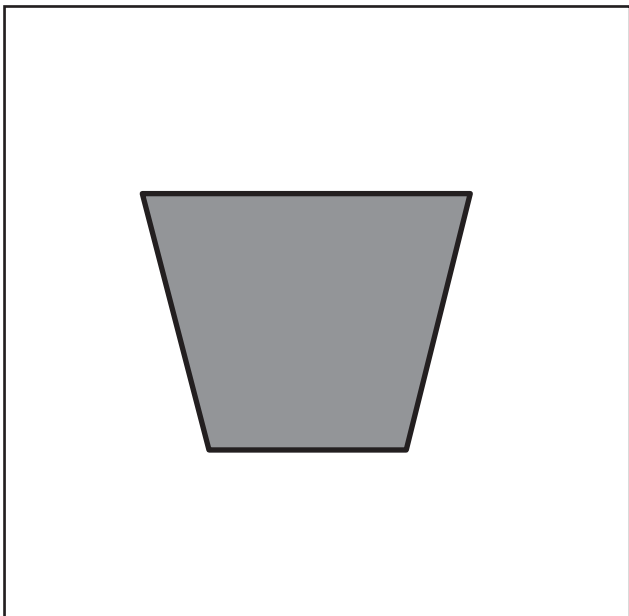
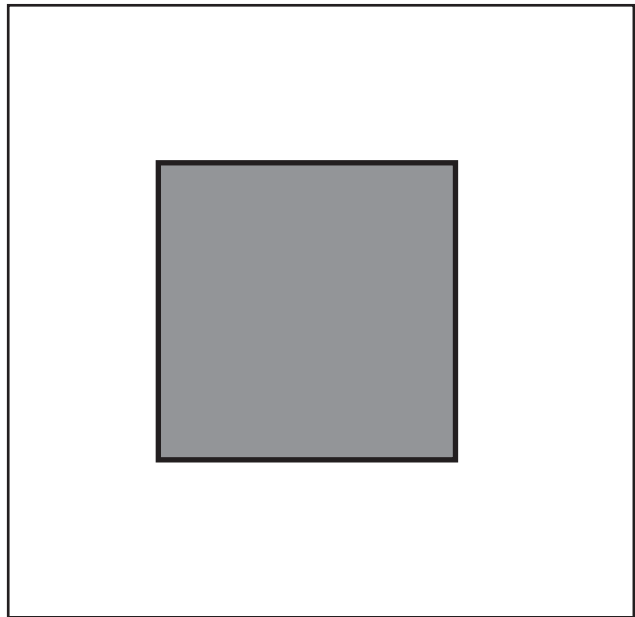
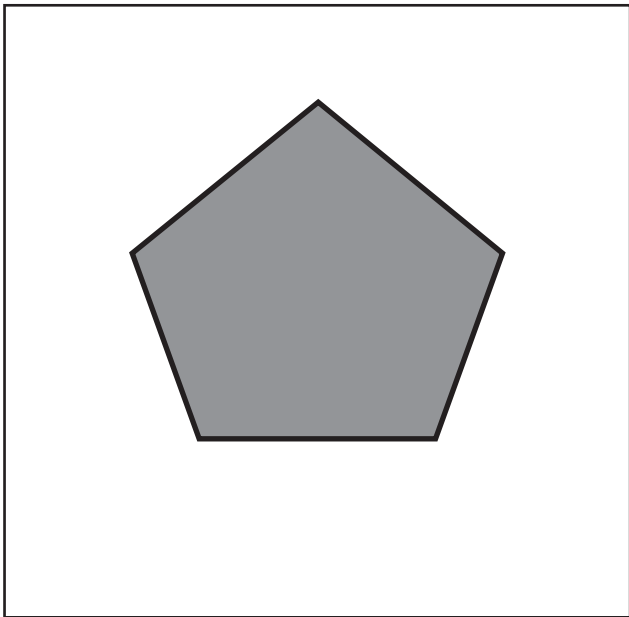

Приложение 7, занятие 3

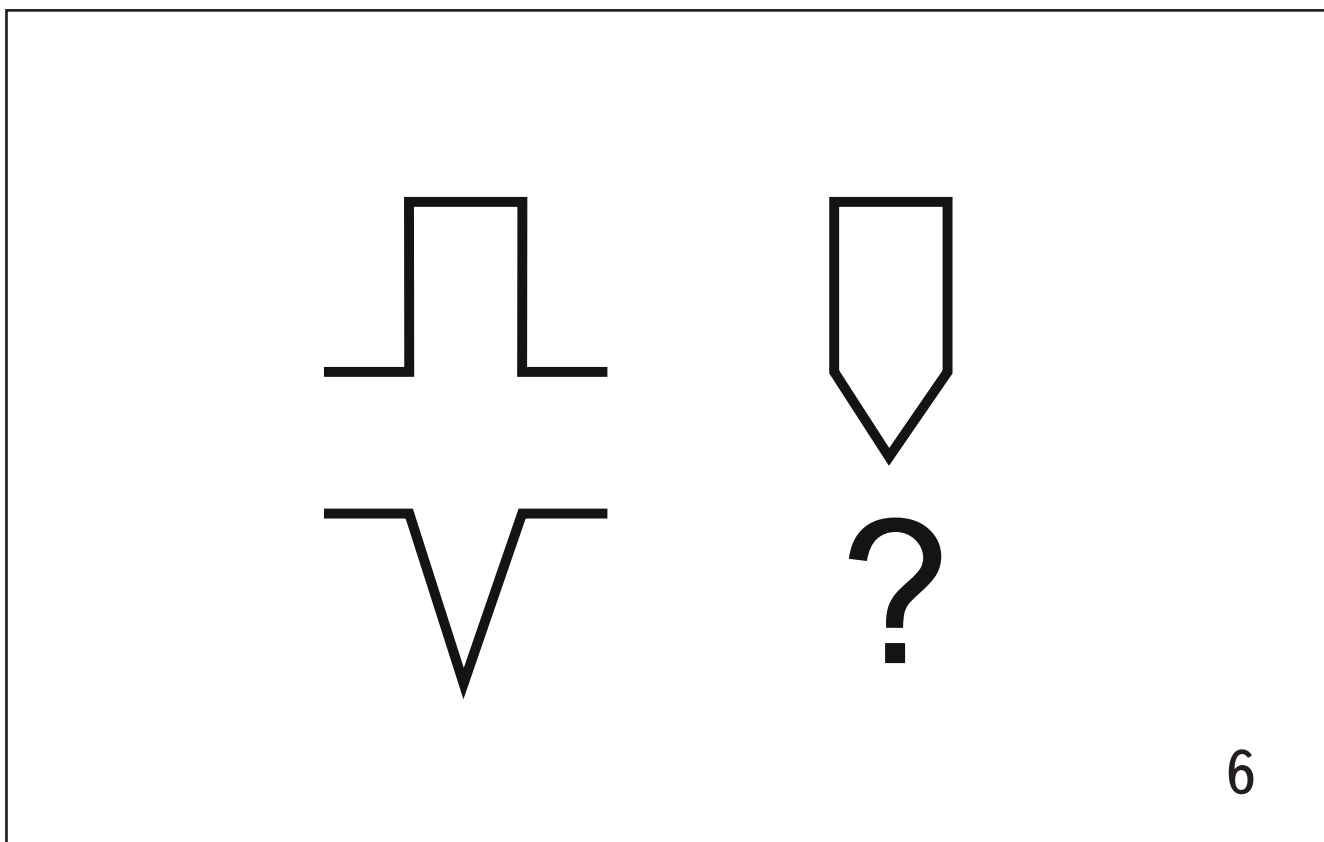
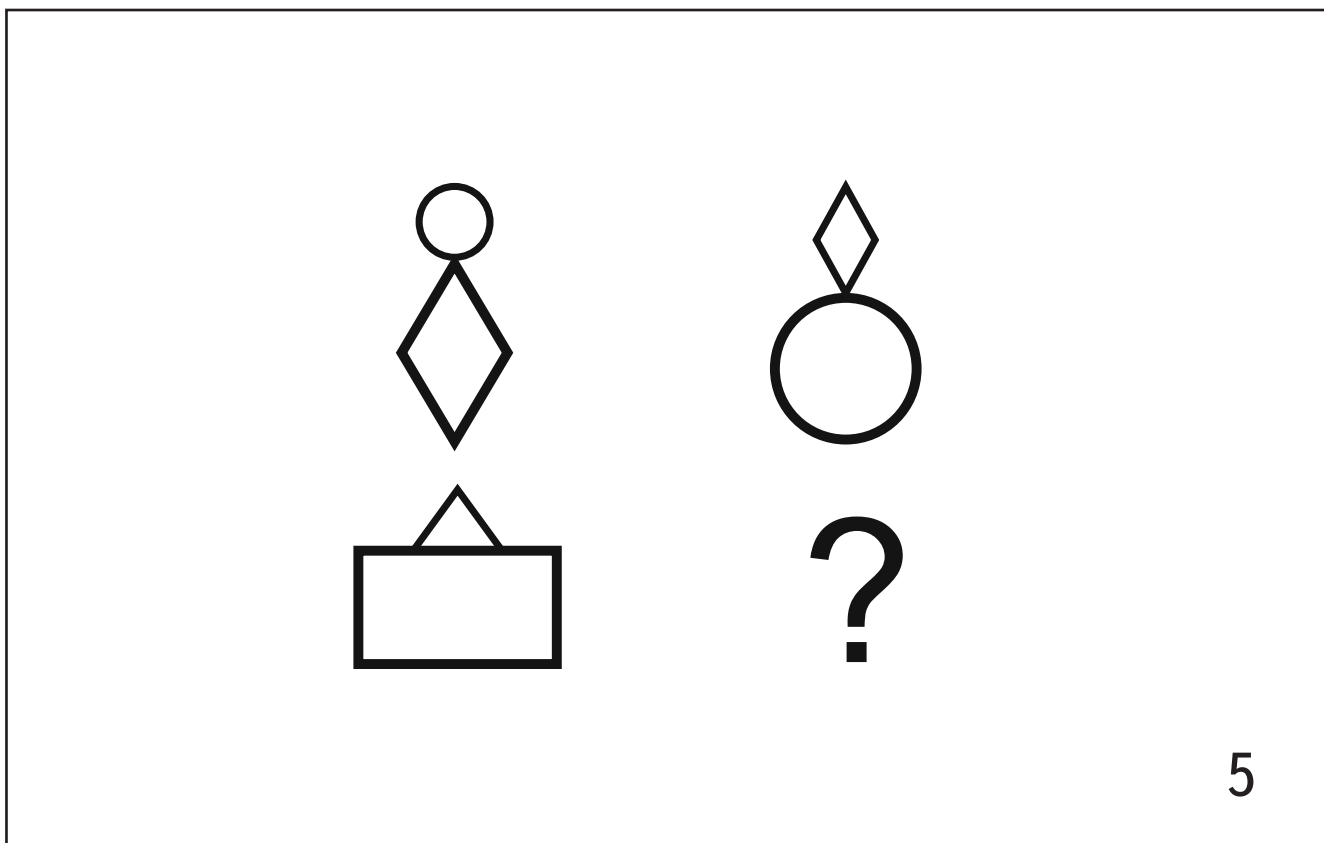

Приложение 7, занятие 3

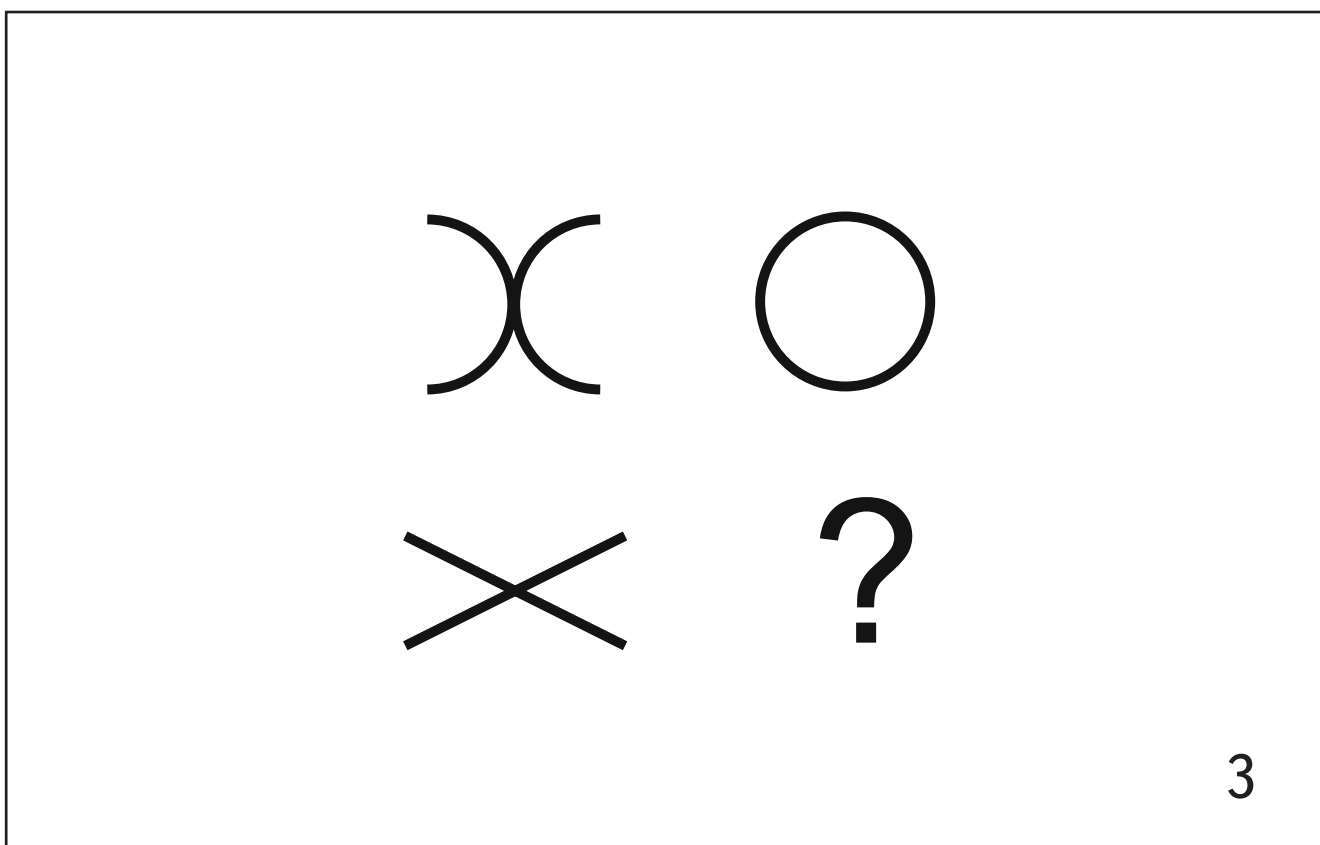

3

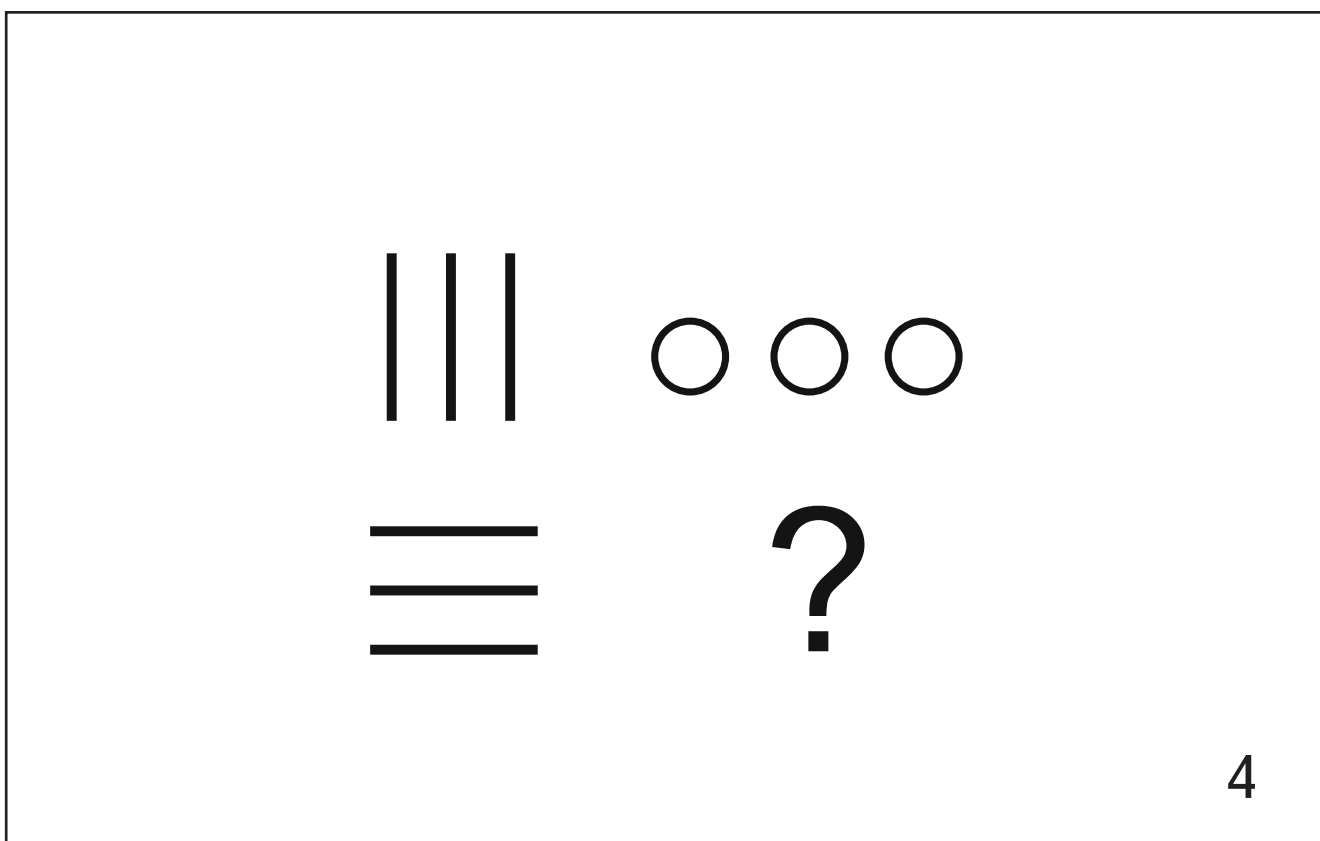

4

Приложение 5, занятие 2

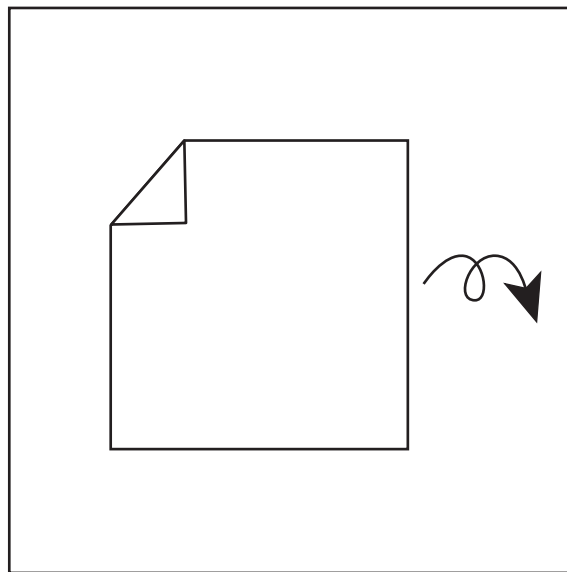
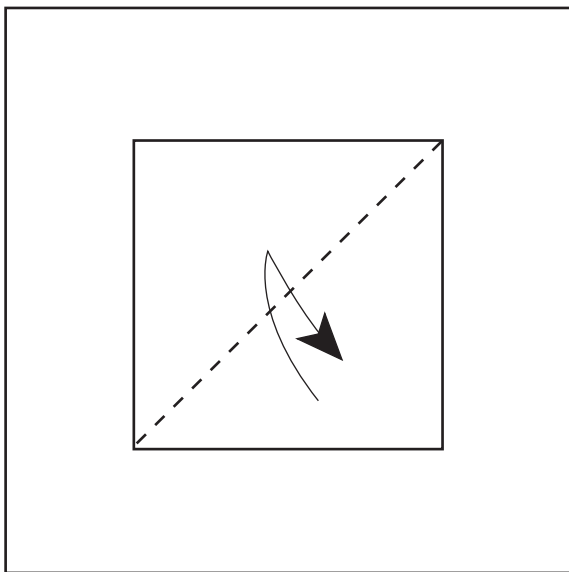
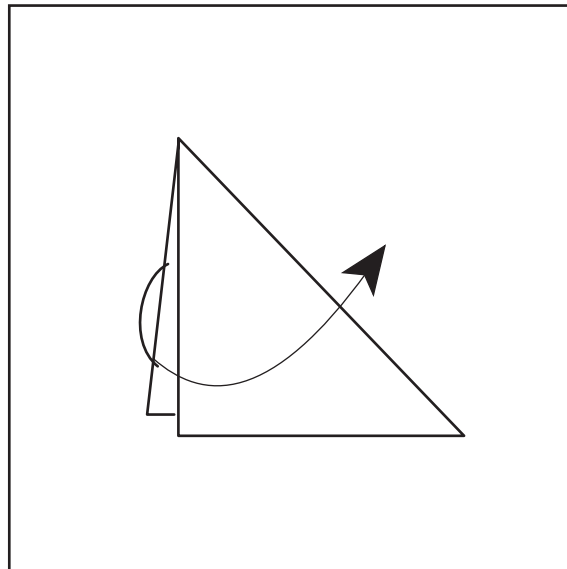
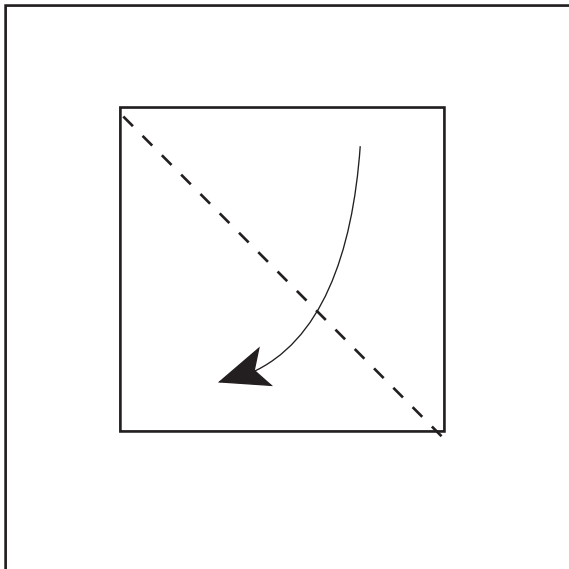

Приложение 6, занятие 2

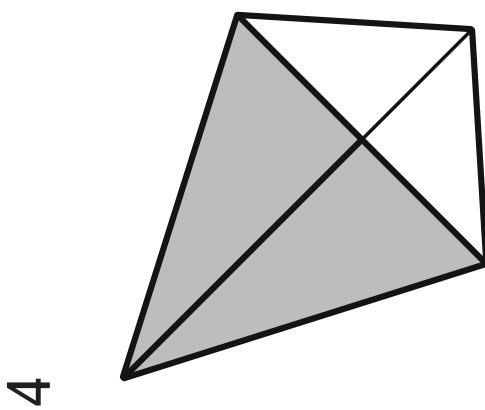
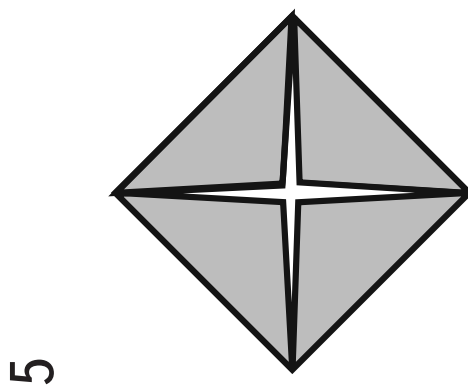
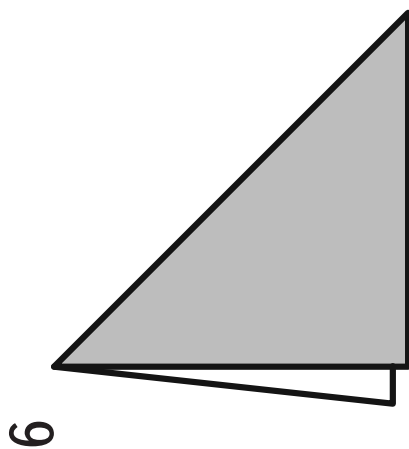

перевернуть

**согнуть с двух
сторон**

вогнуть внутрь

**складка к себе
(«долиной»)**

**сложить
и развернуть**

**раскрыть
карман**

Приложение 3, занятие 1

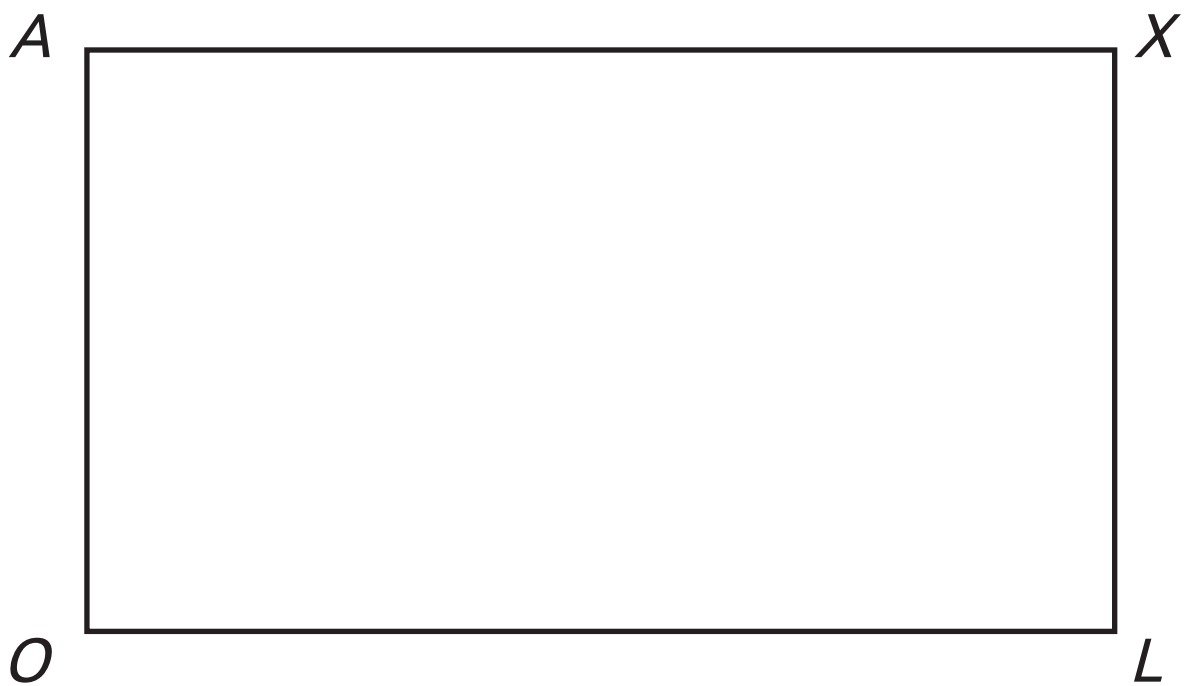
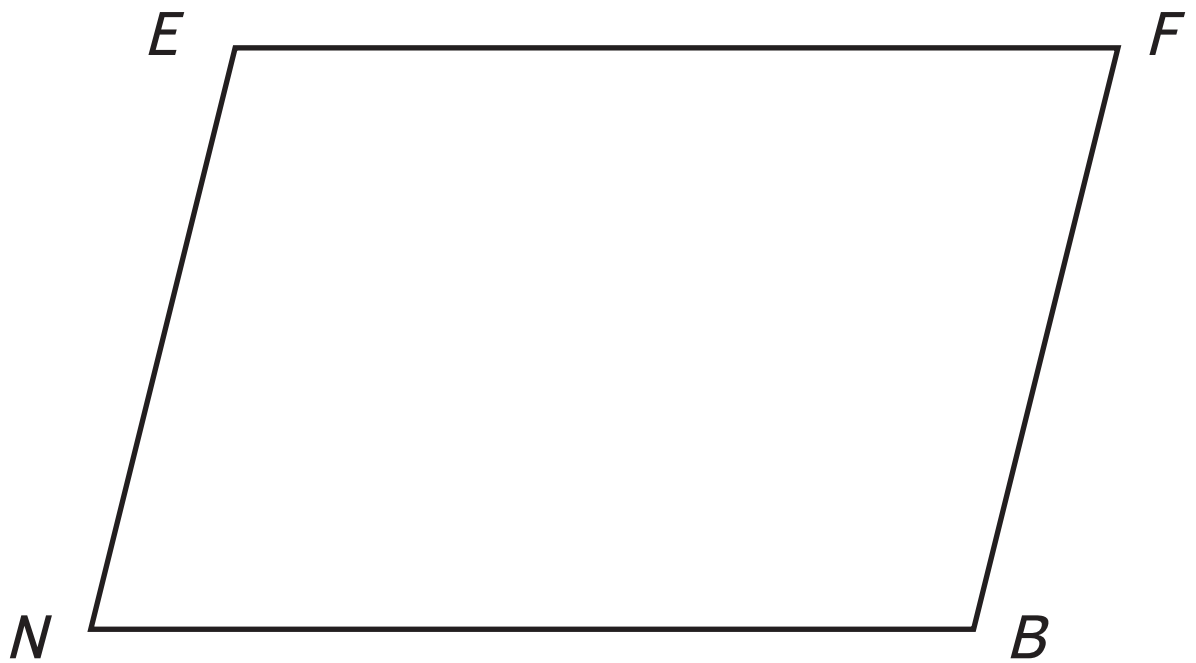

Приложение 1, занятие 1

5

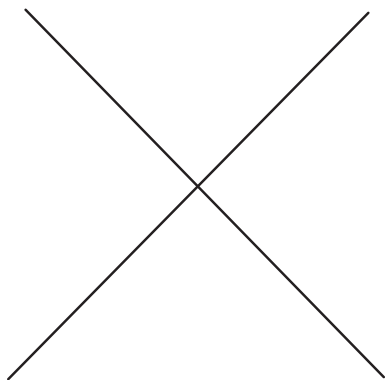

7

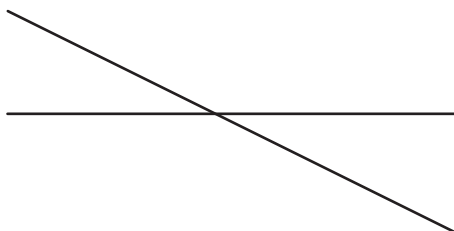

6

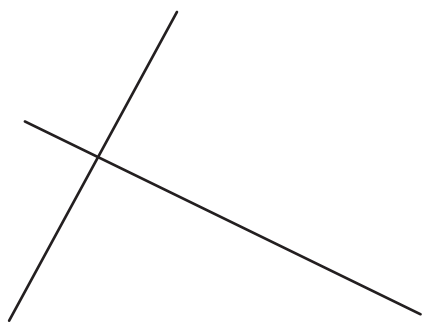

8

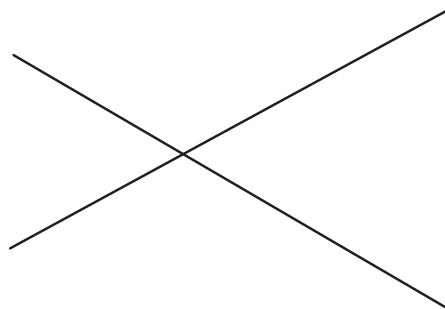

Приложение 2, занятие 1

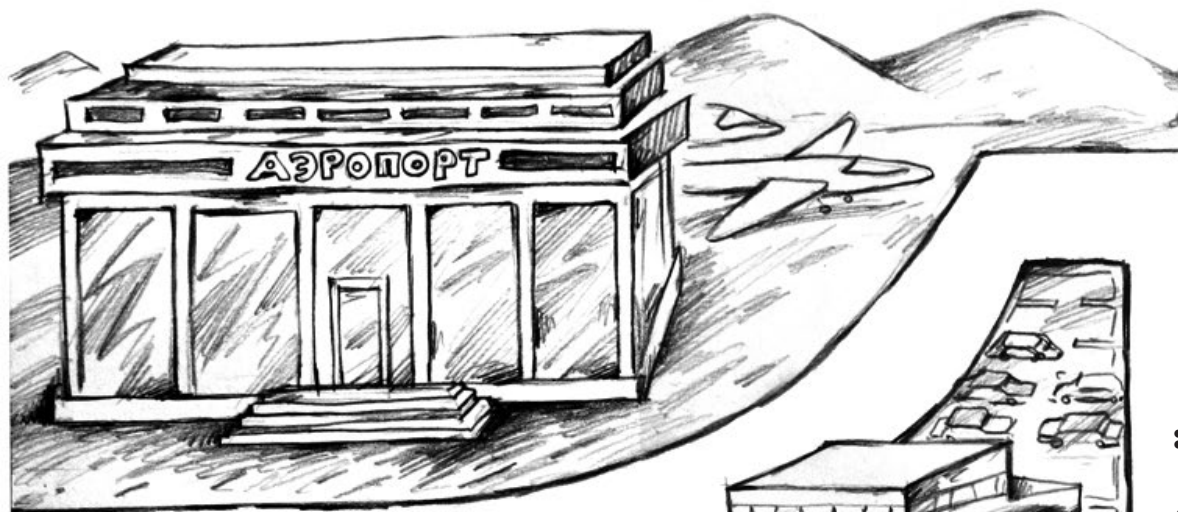

Мандариновая

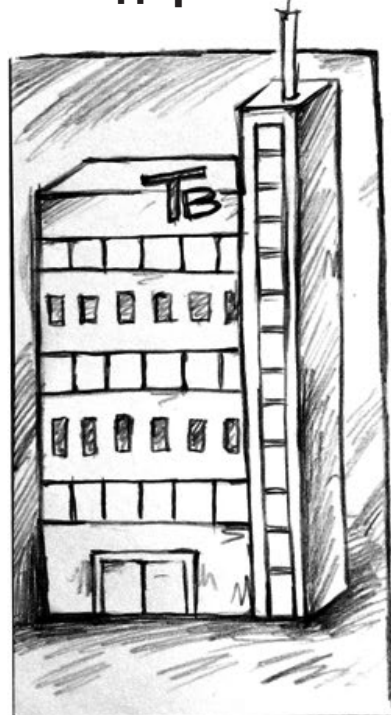
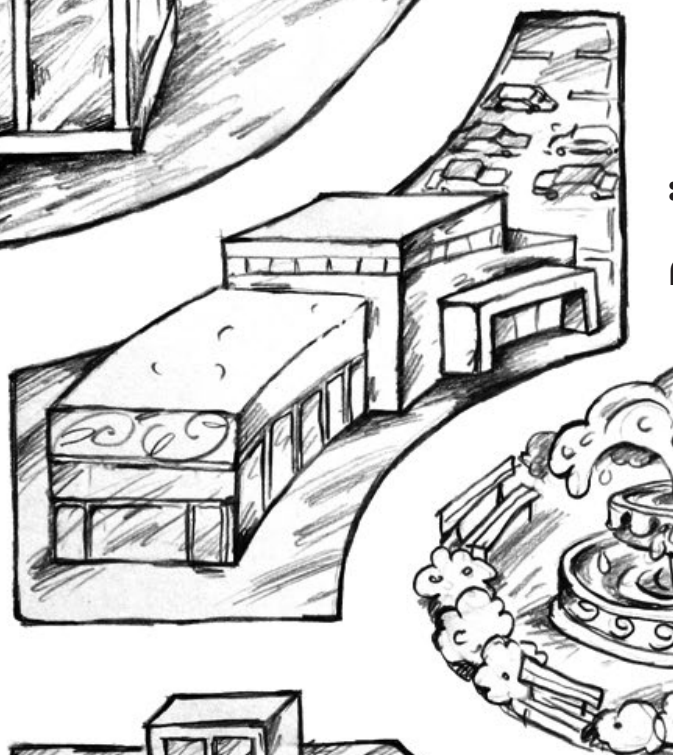

Дружная

Яблочная





Абрикосовая

Веселая

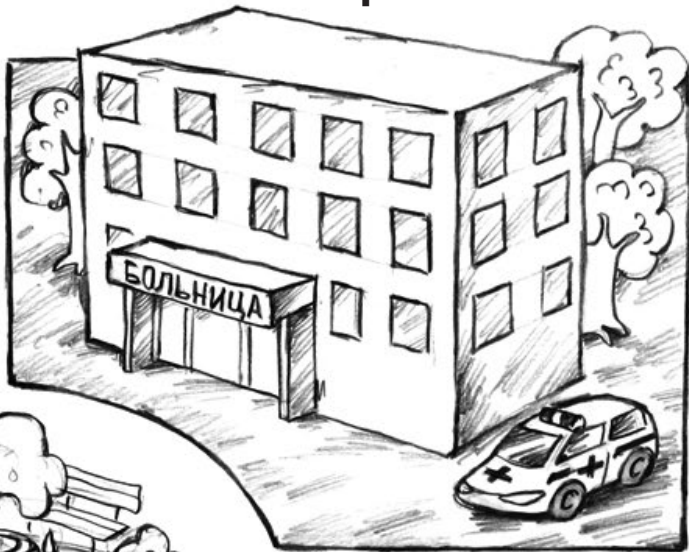

Шутливая

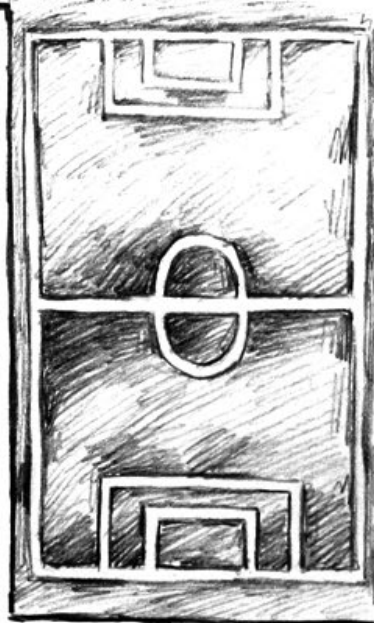

Апельсиновая

Забавная

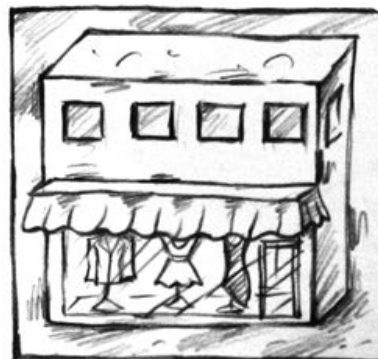

Шутливая

Яблочная

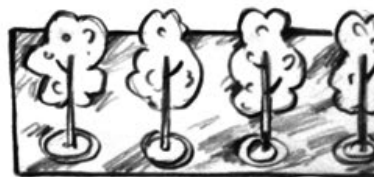

Сливовая

Приложение 1, занятие 1

1

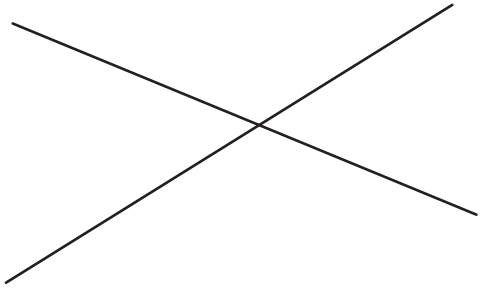

3

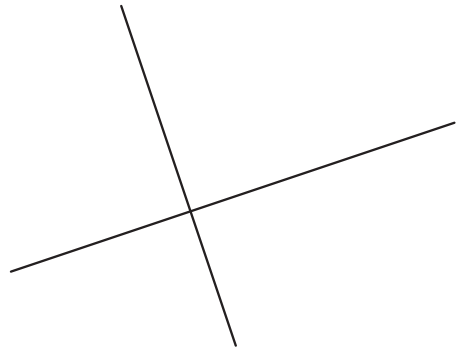

2

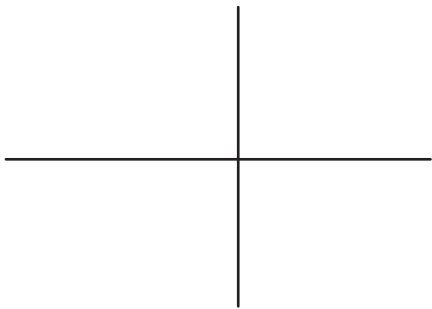

4

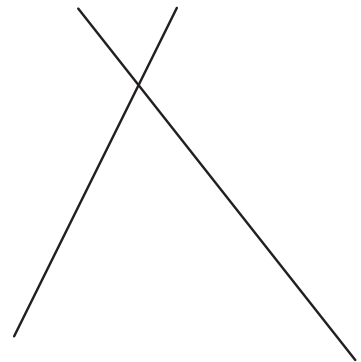

Приложение 3, занятие 1

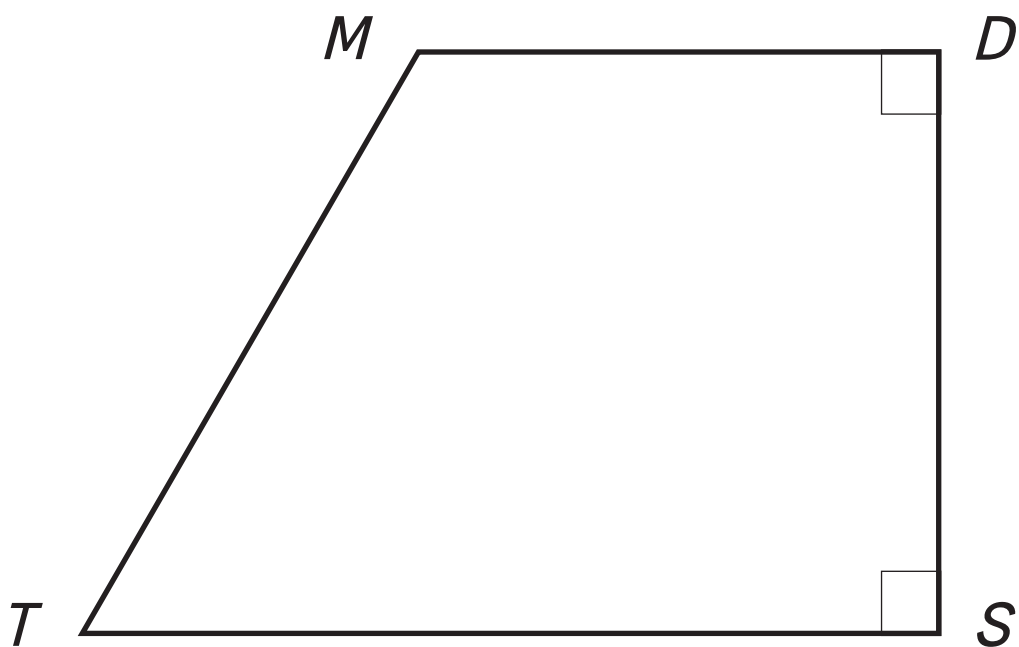
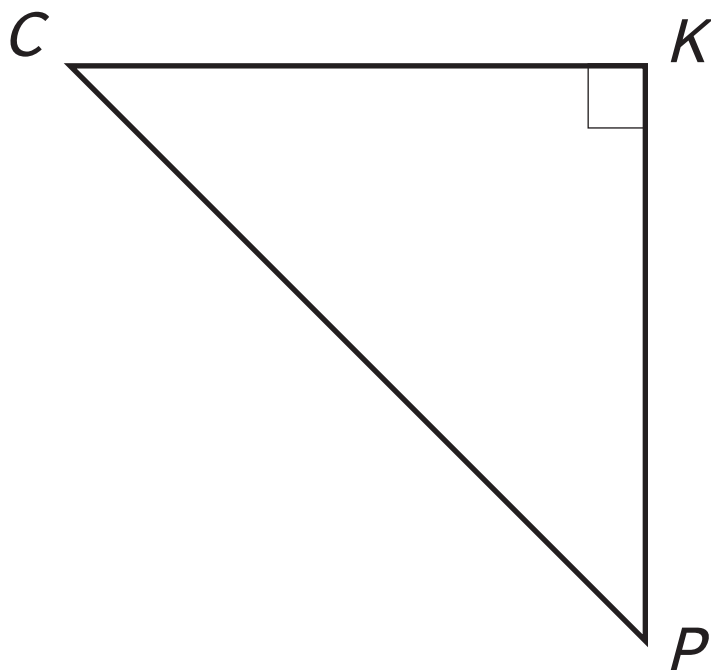

СЛОЖИТЬ

развернуть

**складка от себя
(«горкой»)**

Приложение 5, занятие 2

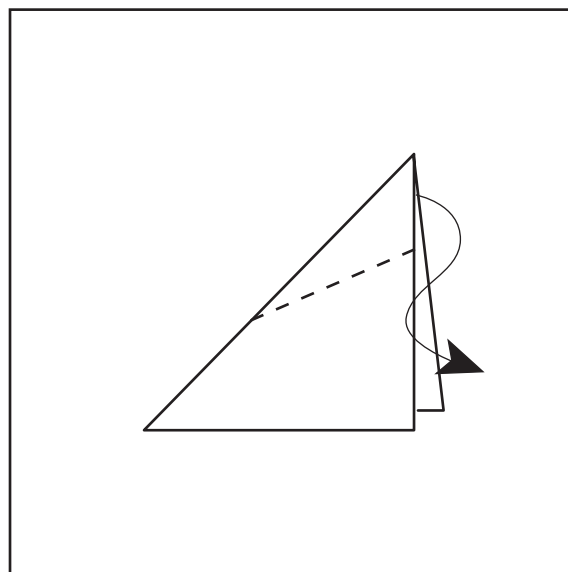
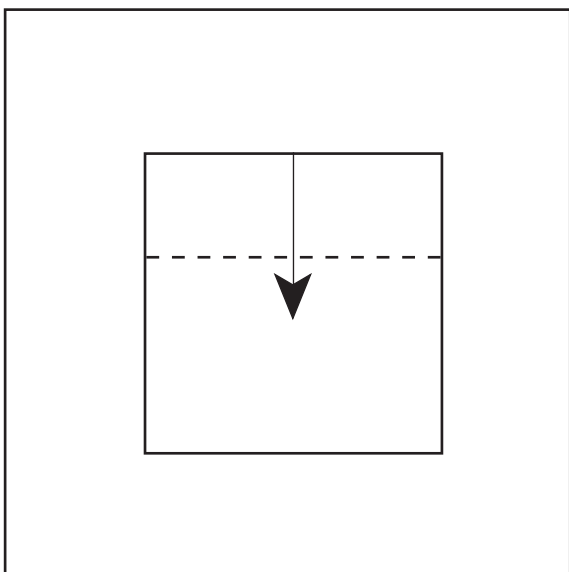
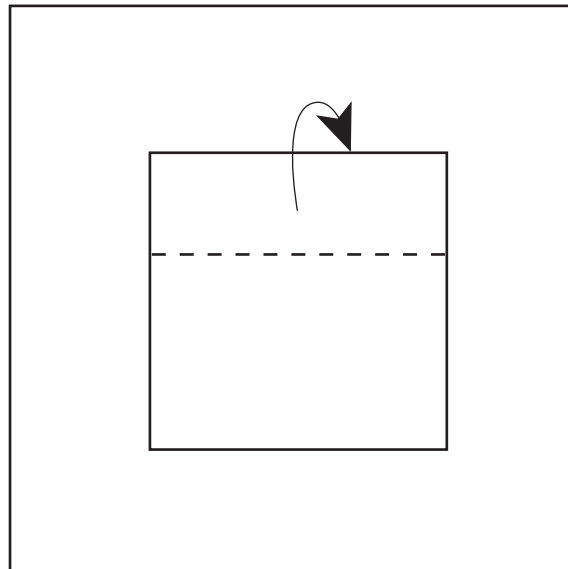
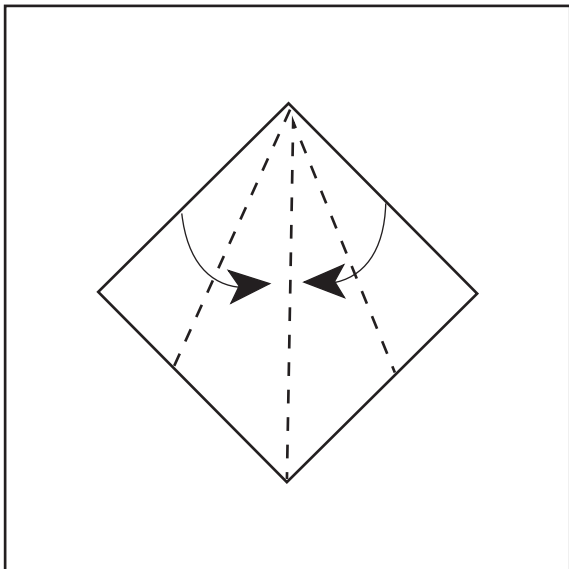

Приложение 6, занятие 2

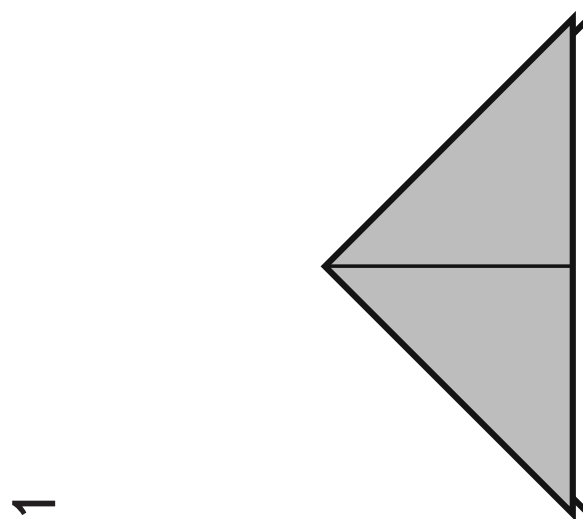
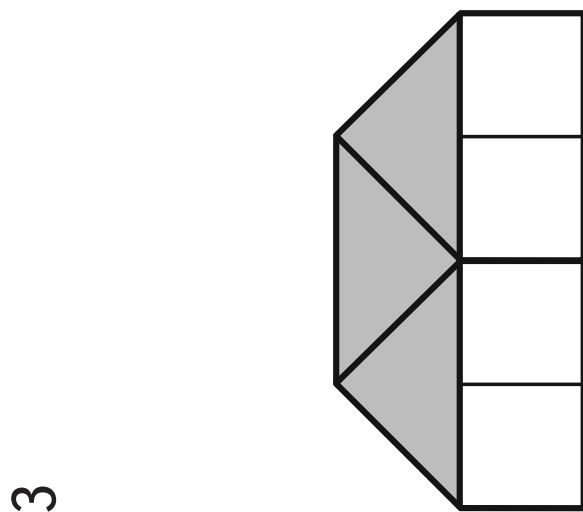

Приложение 5, занятие 2

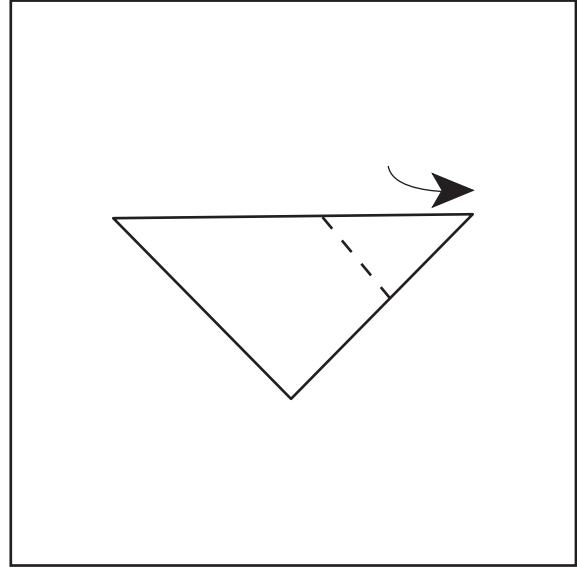
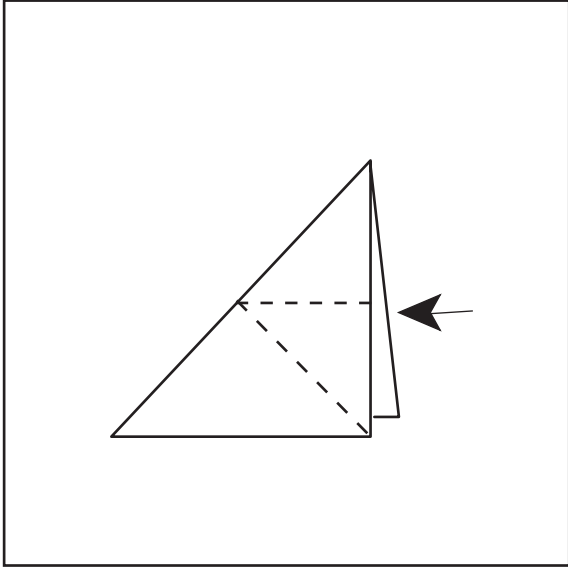

Приложение 7, занятие 3

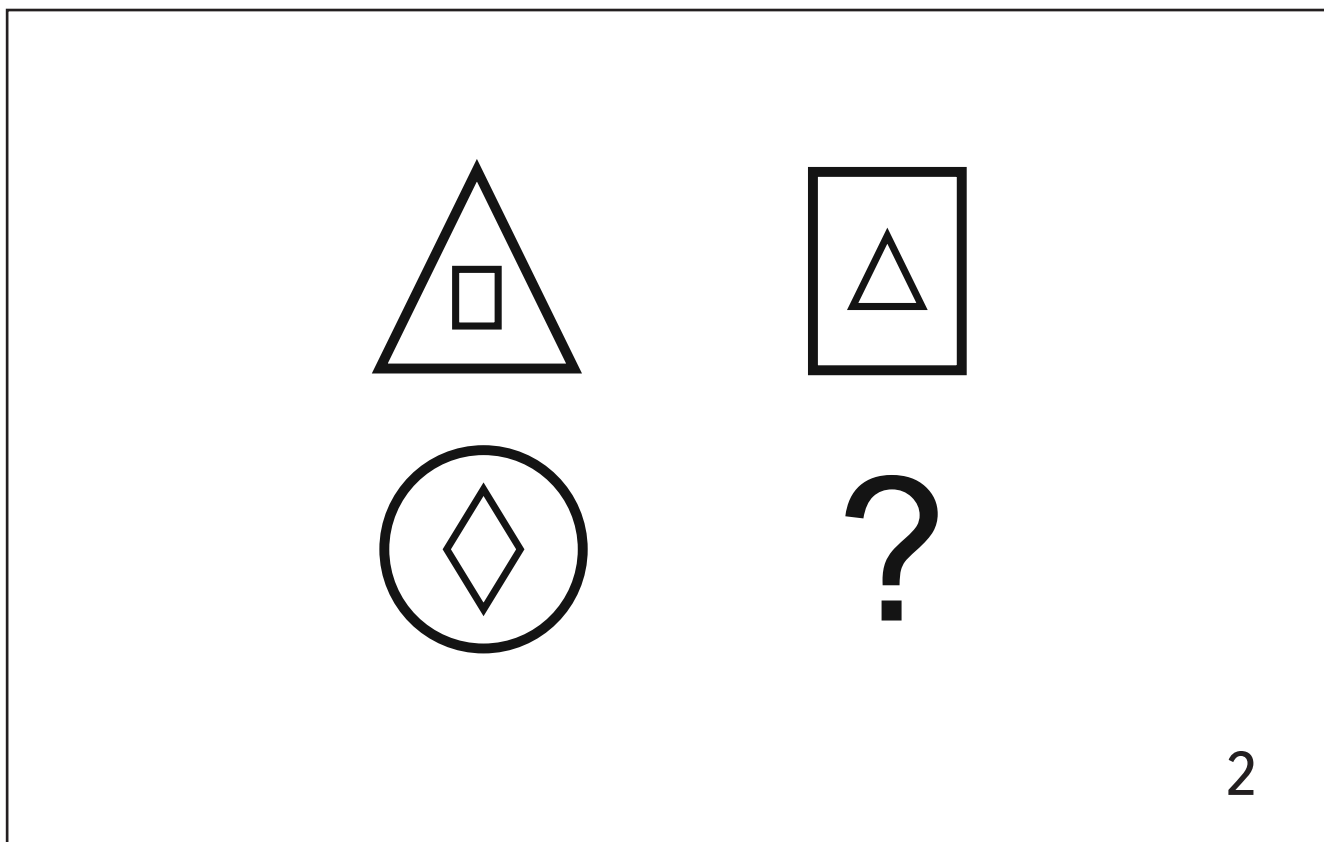
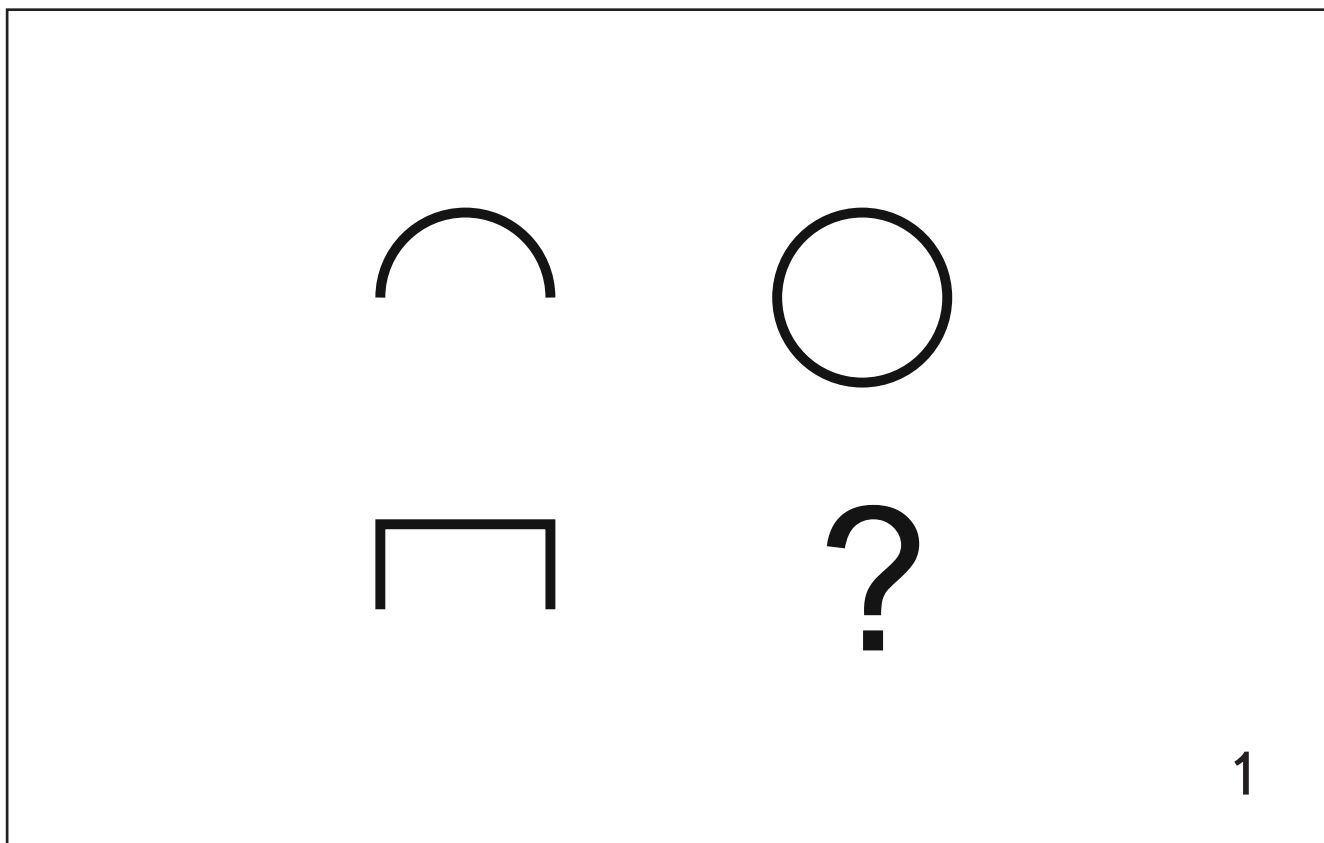

Приложение 7, занятие 3

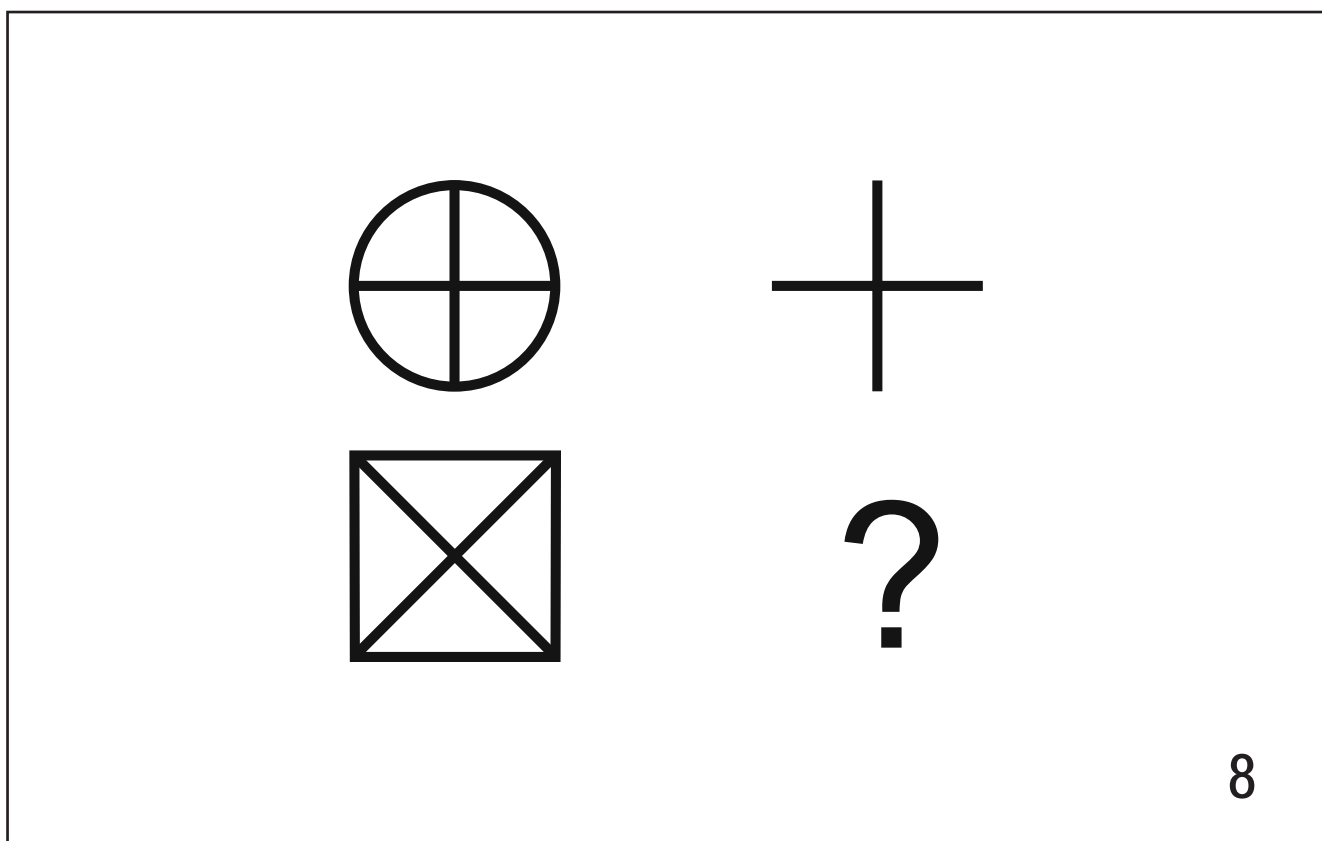
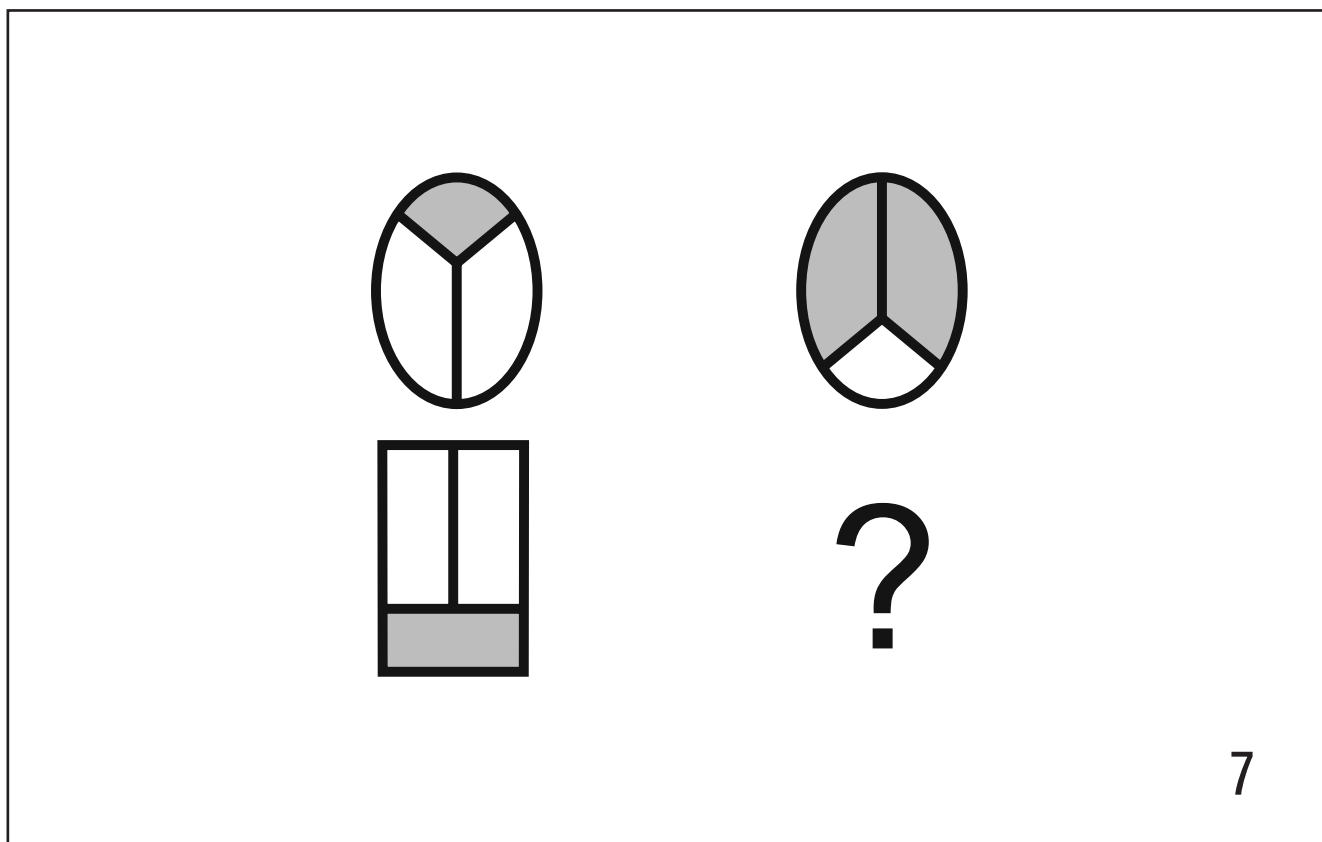

Приложение 13, занятие 5

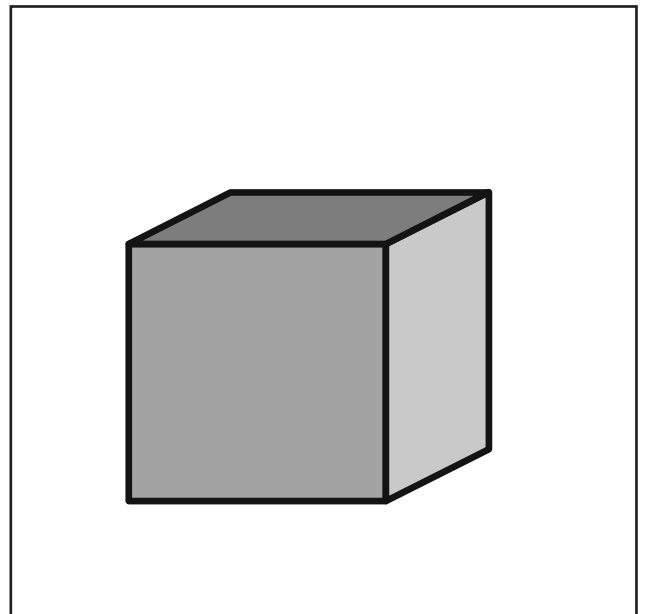
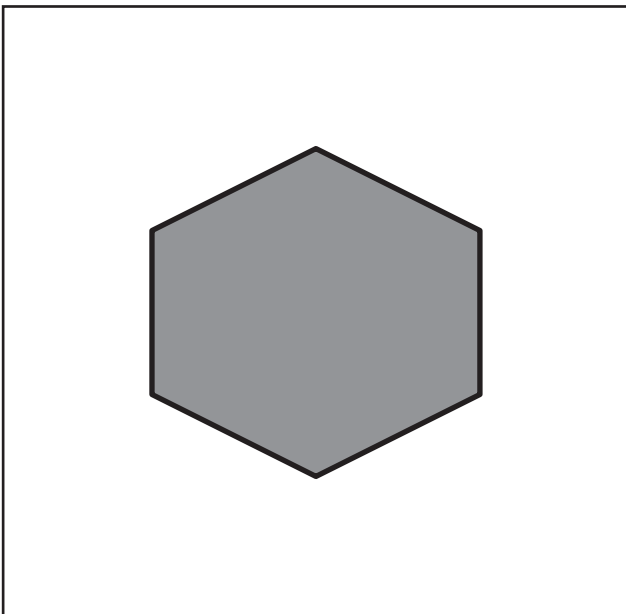
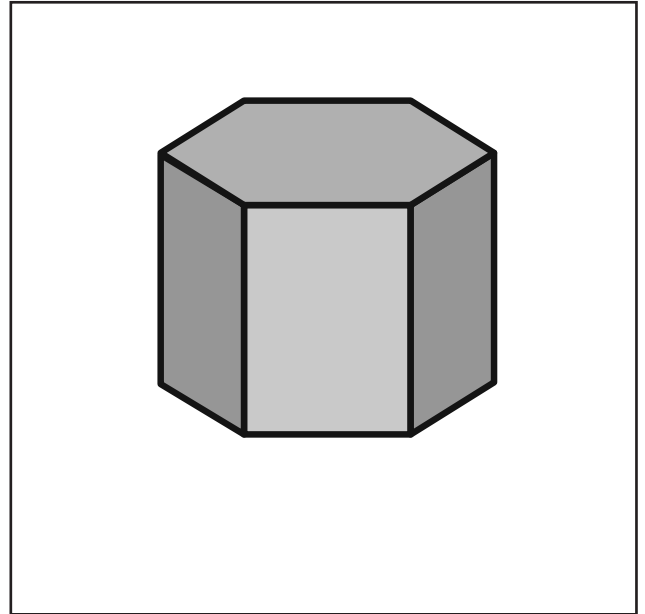
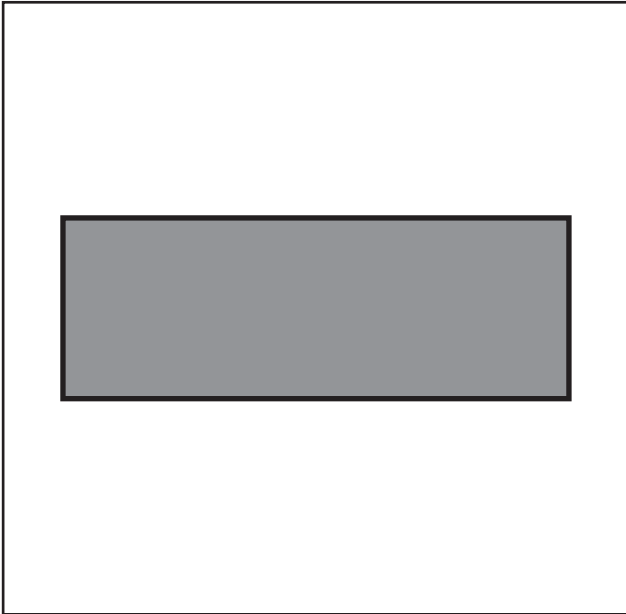

Приложение 13, занятие 5

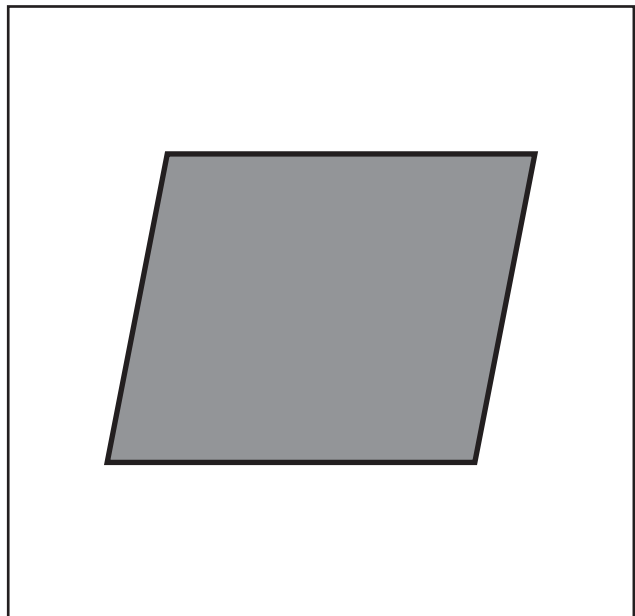
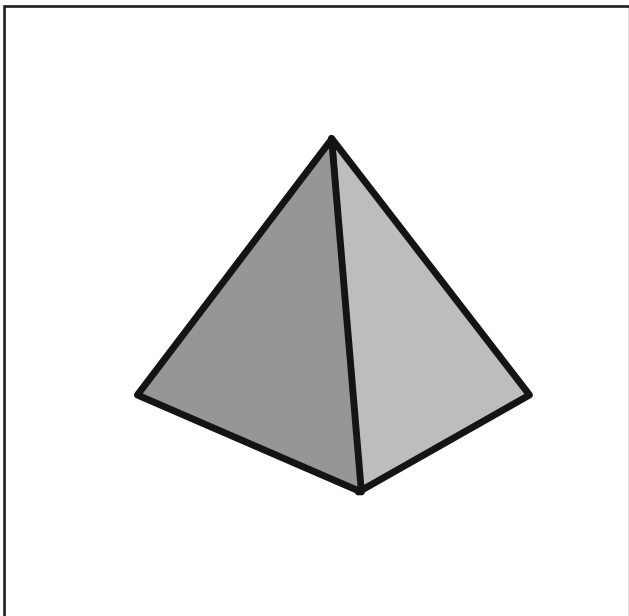
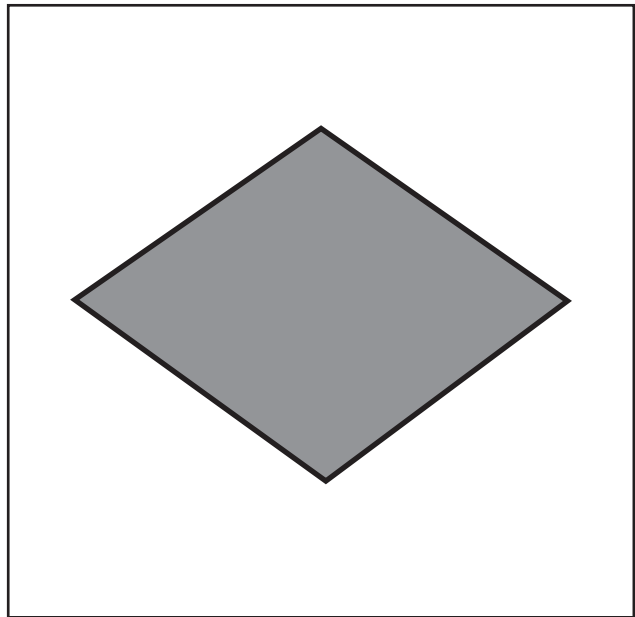
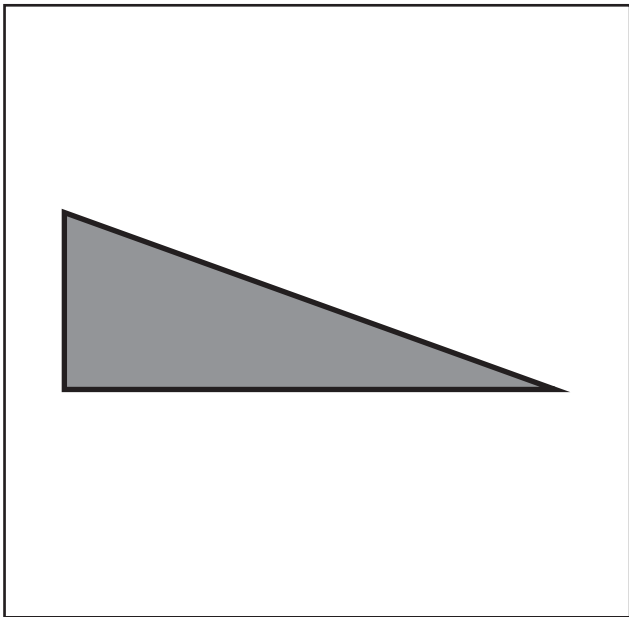

Приложение 8, занятие 3

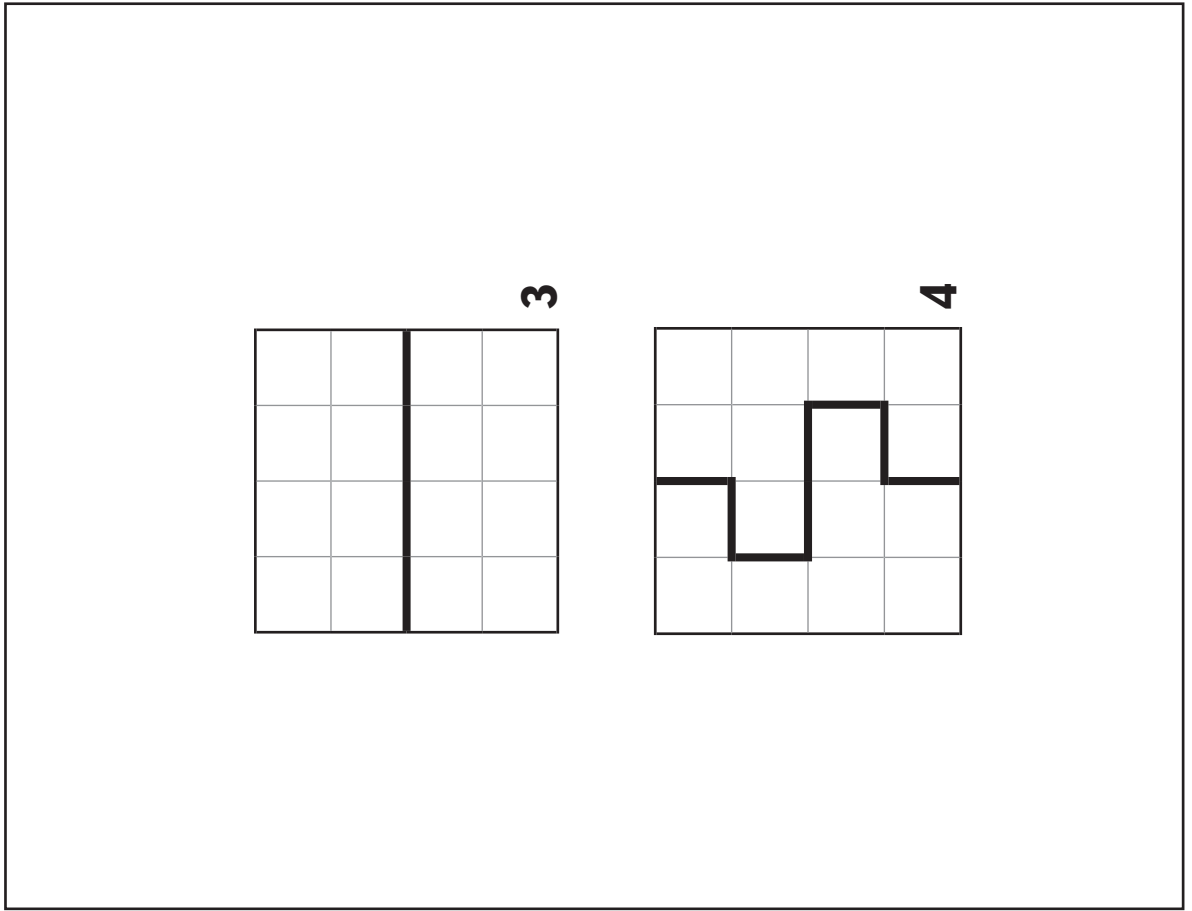
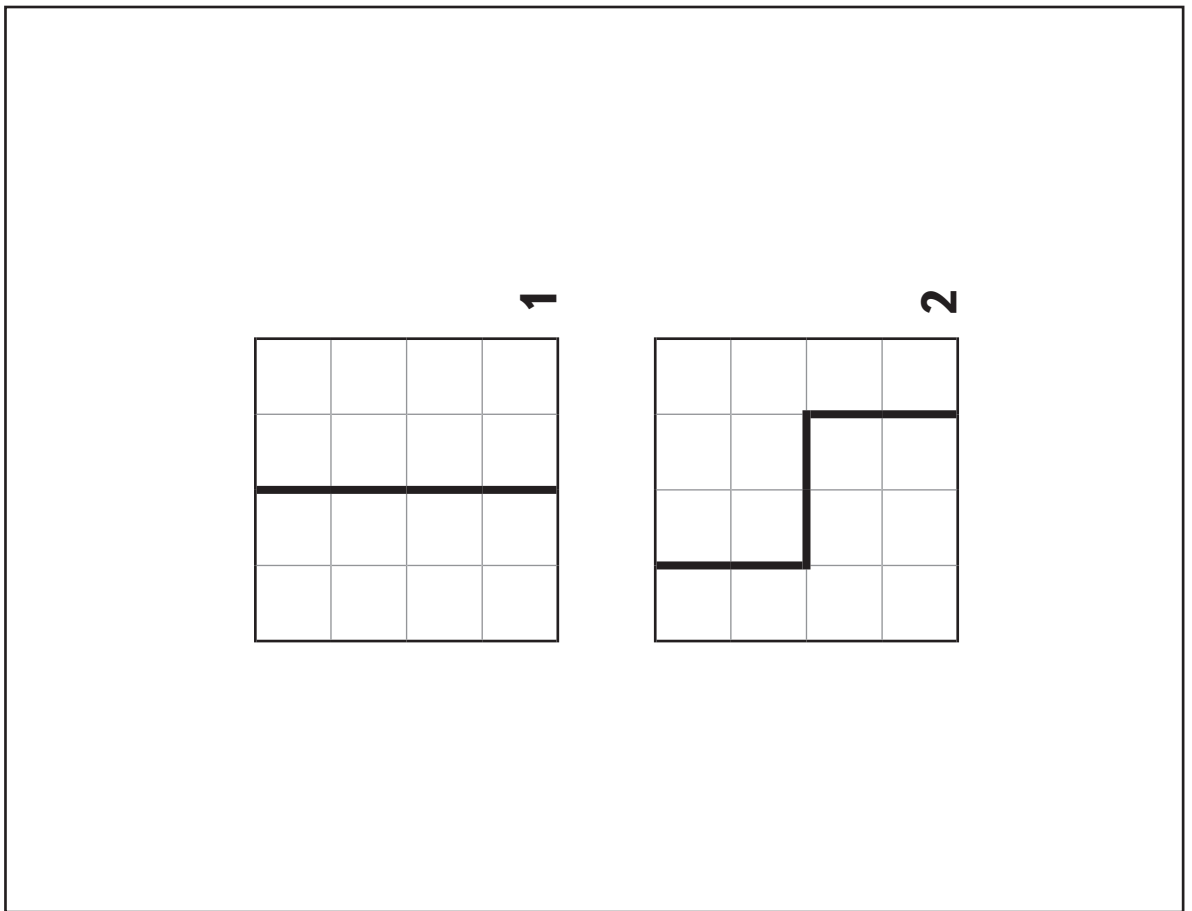

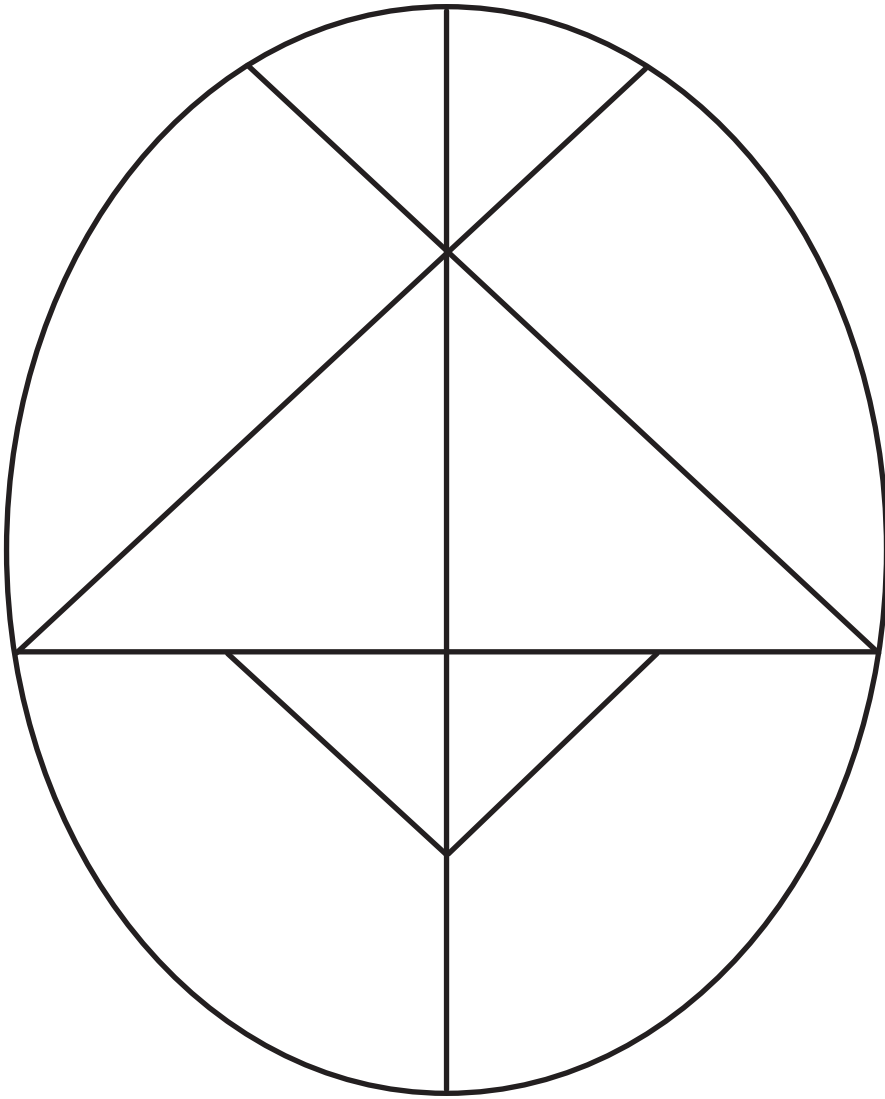

Приложение 12, занятие 4

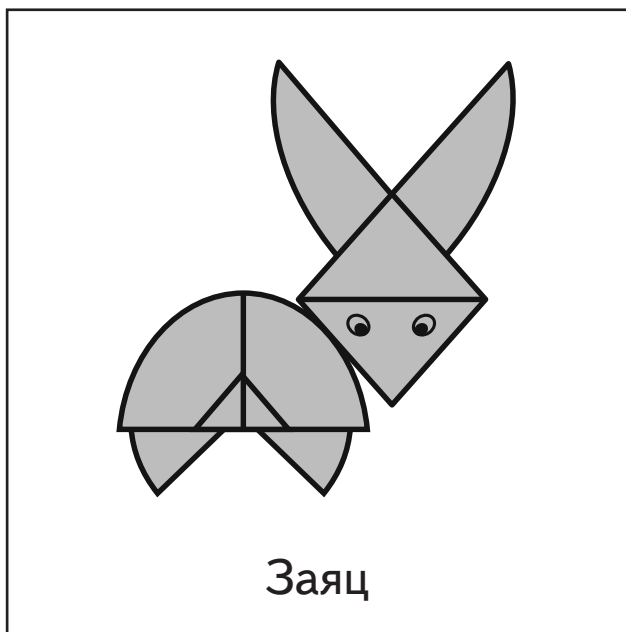
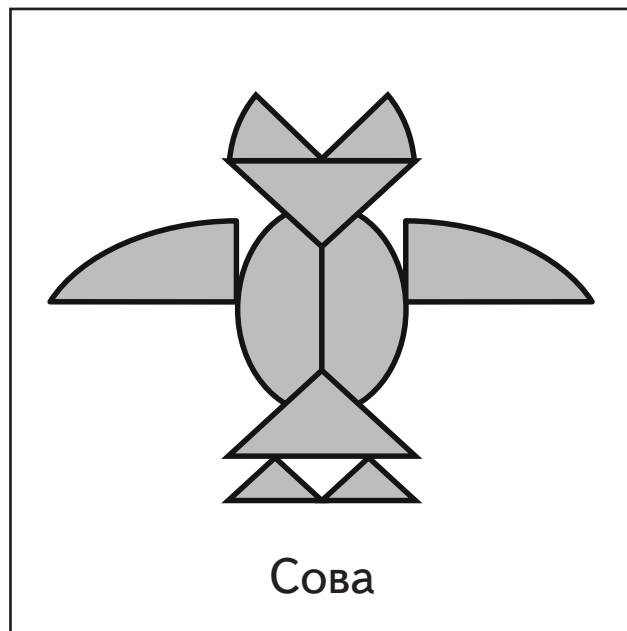
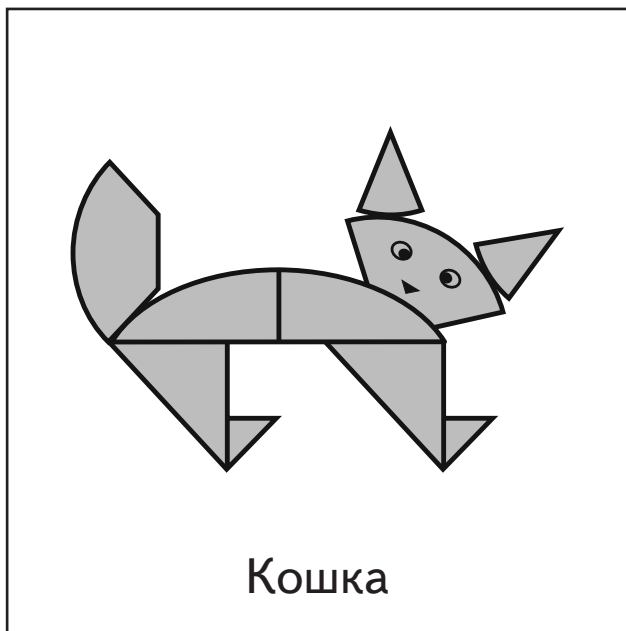

Приложение 12, занятие 4

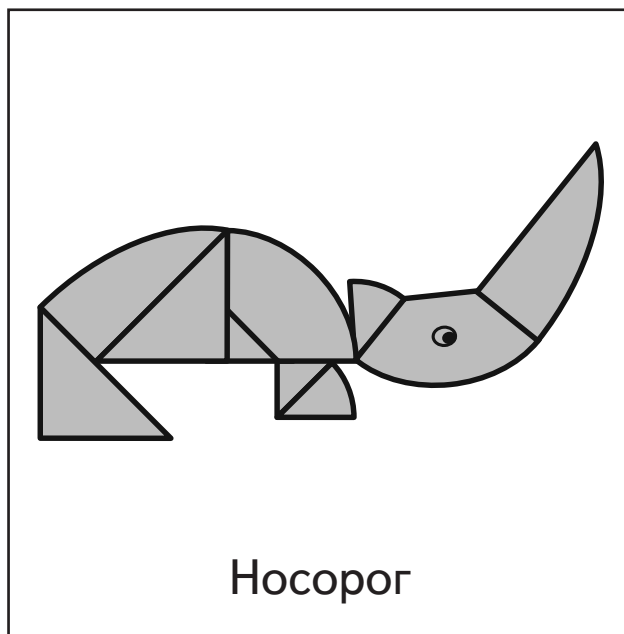
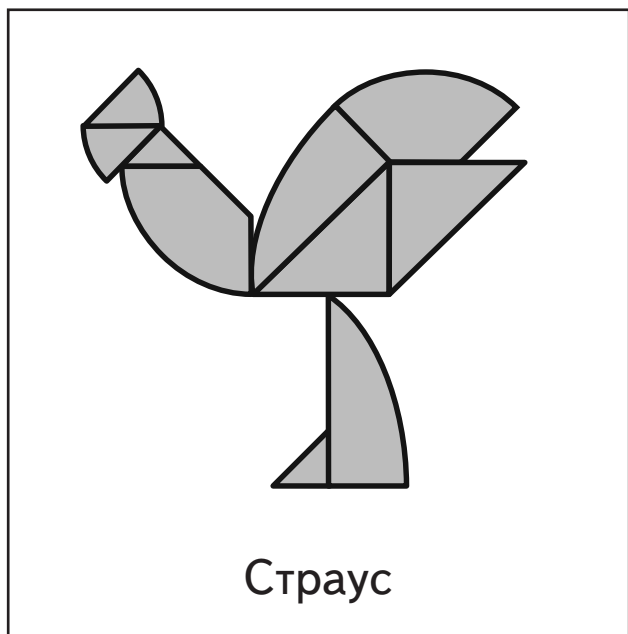
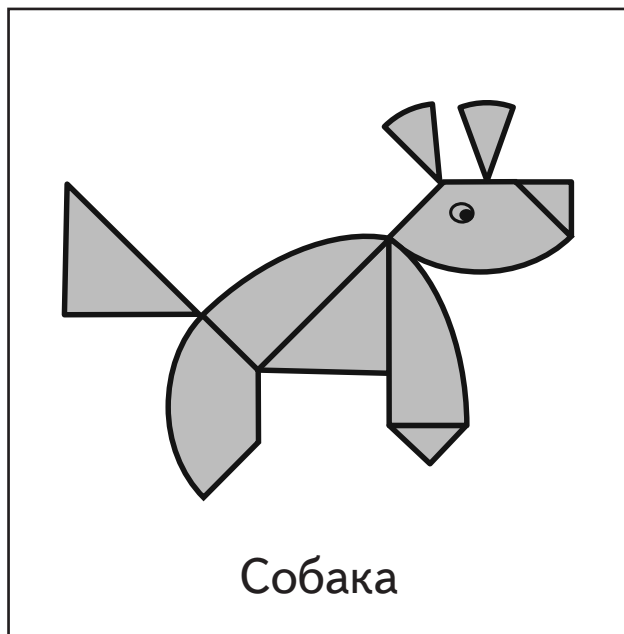
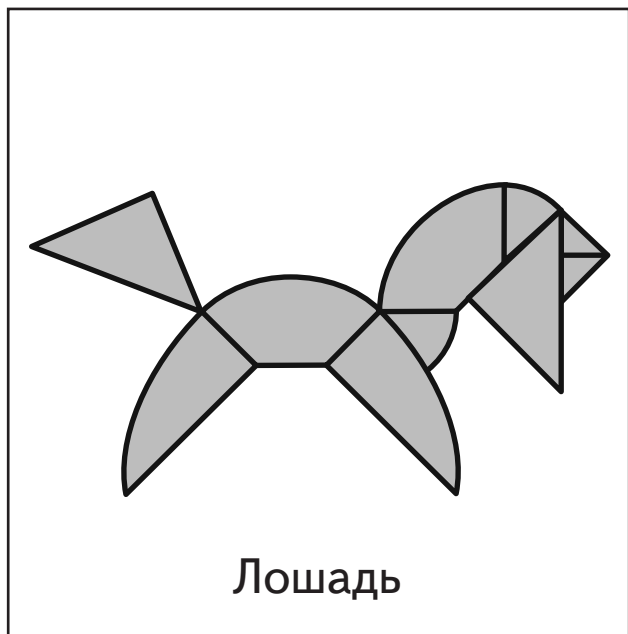

Приложение 14, занятие 5

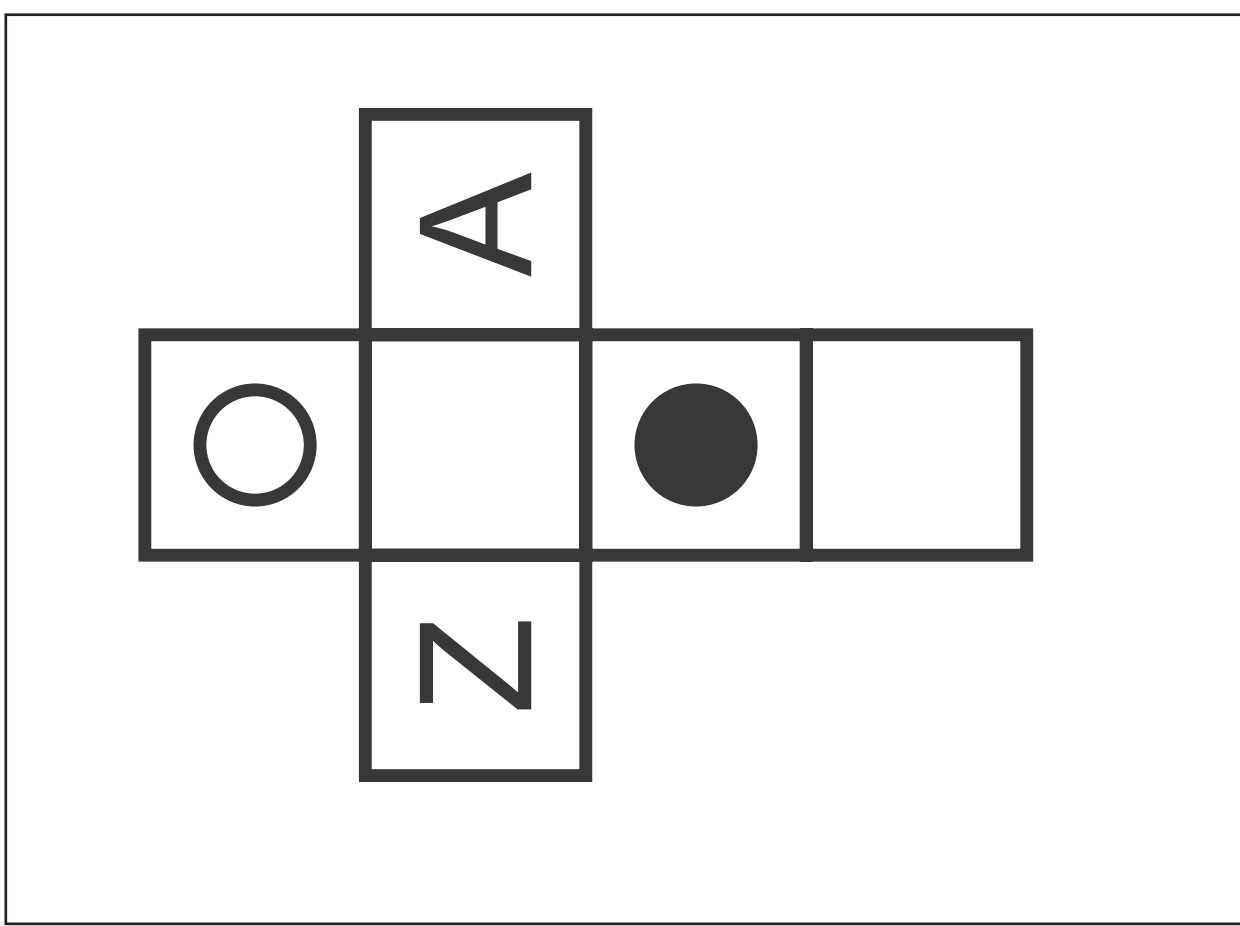
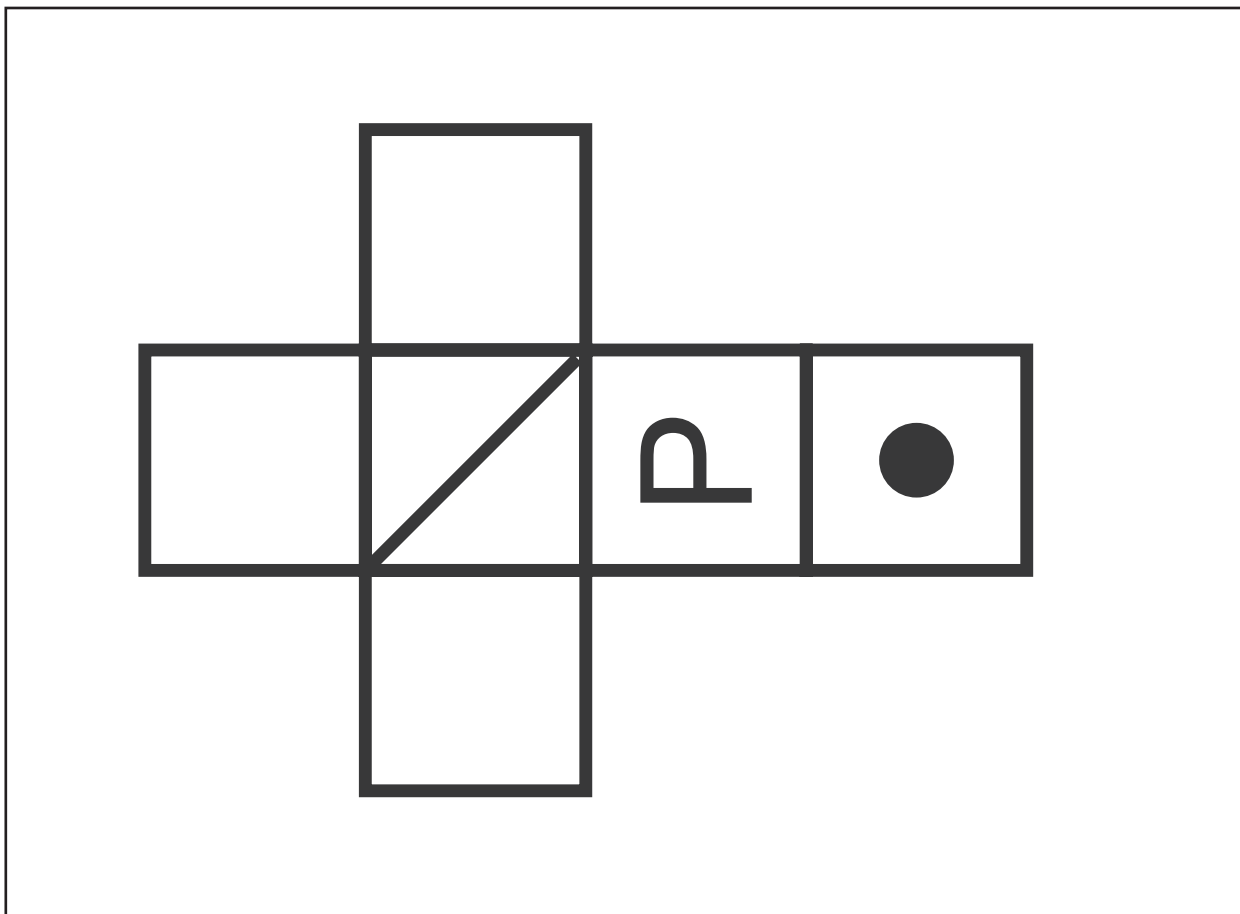

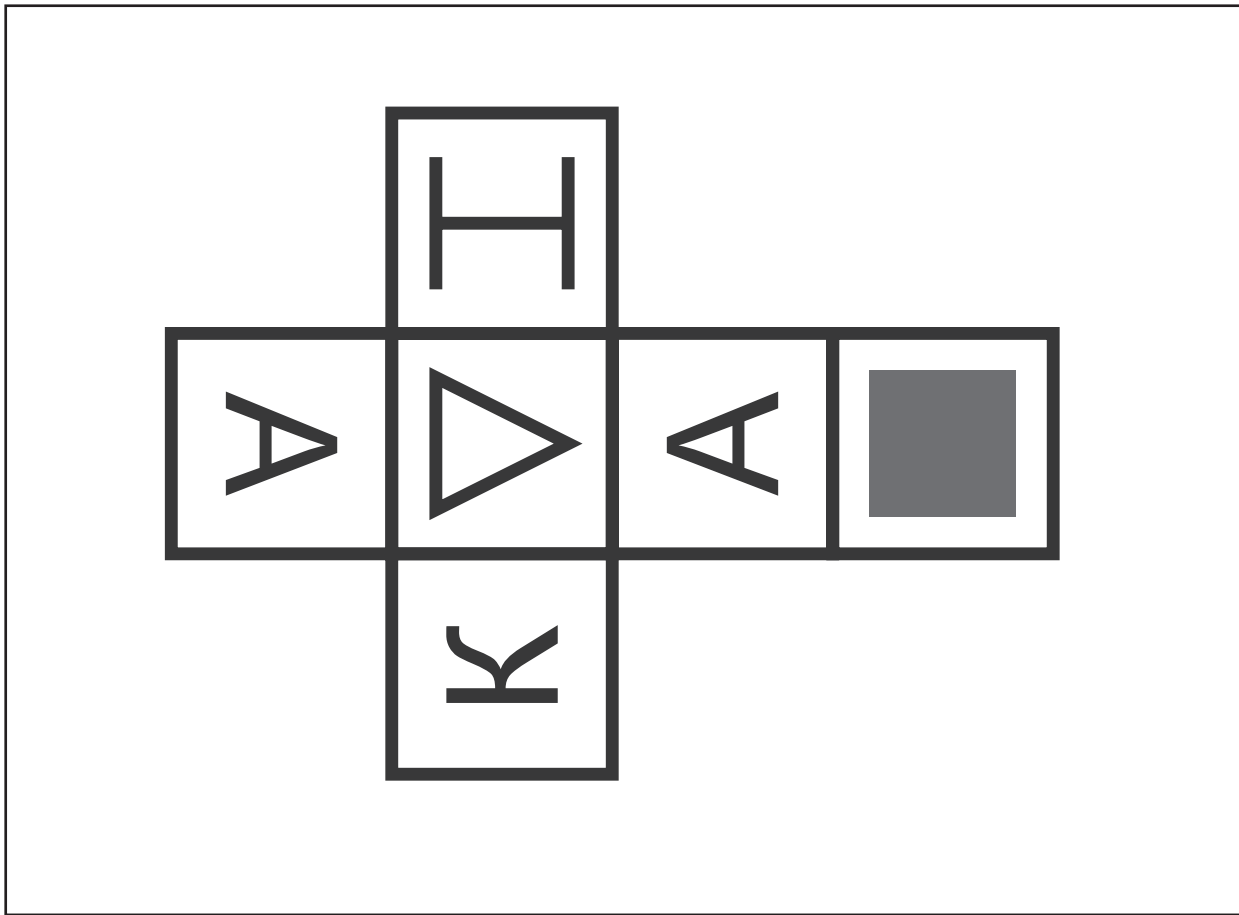
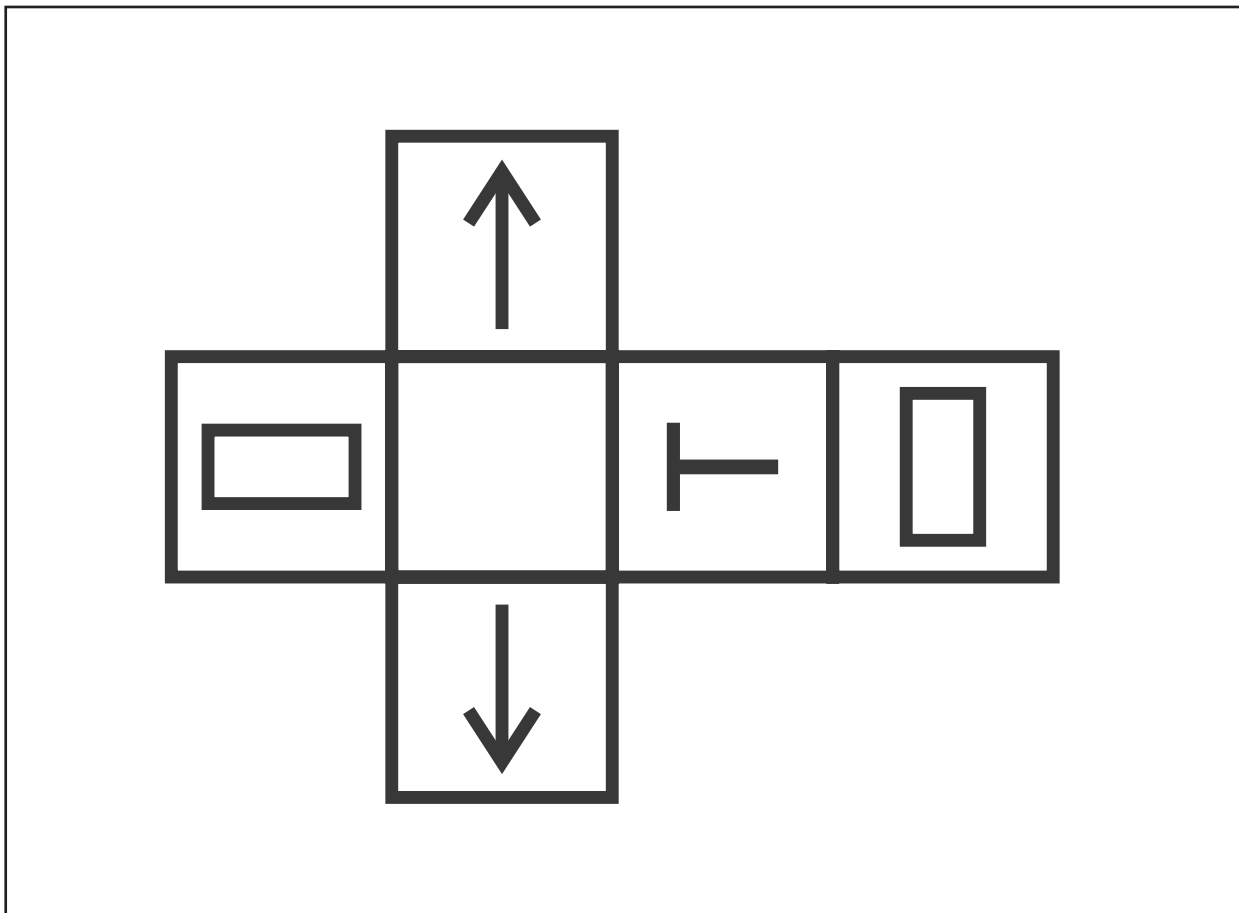

Приложение 16, занятие 6

1

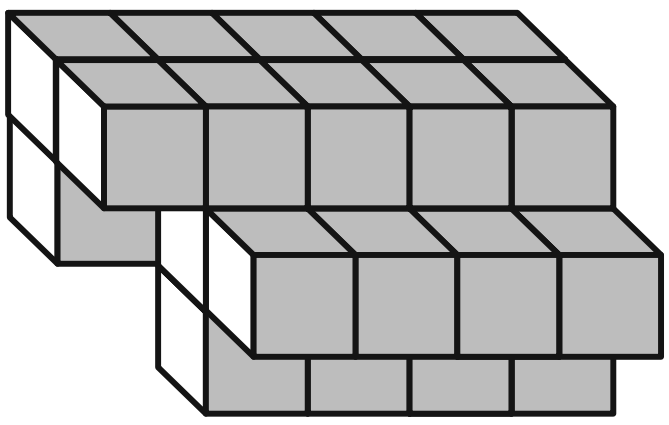

2

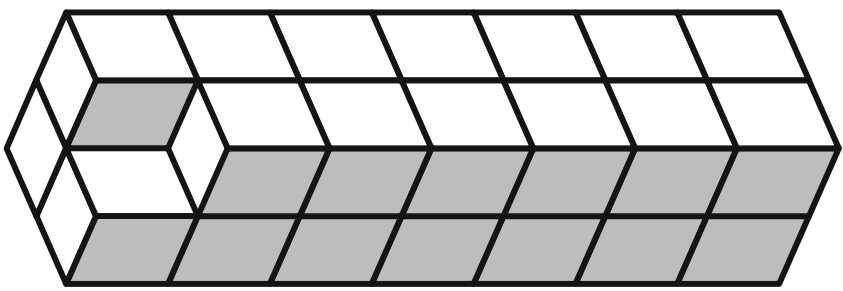

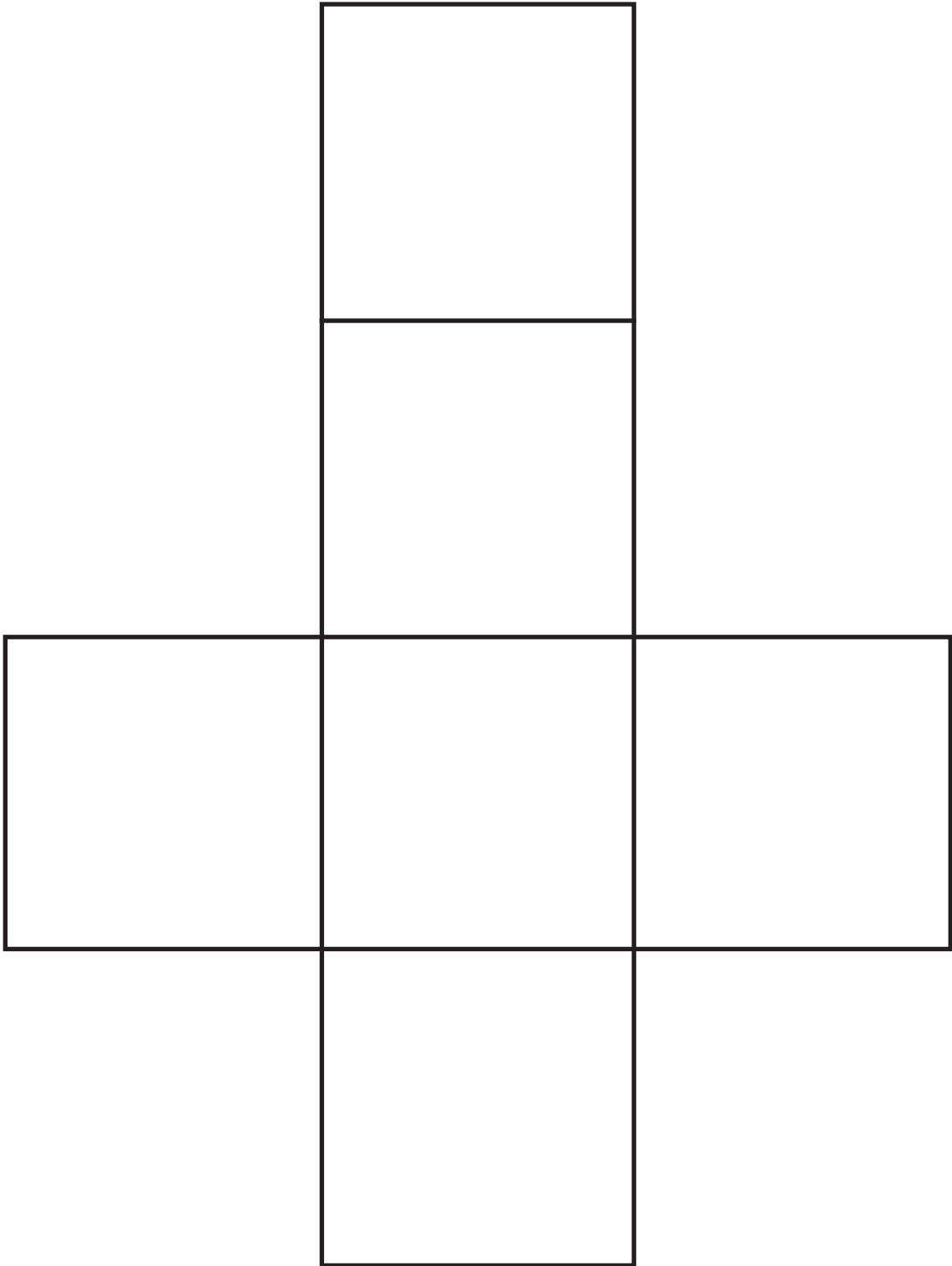

Приложение 19, занятие 7

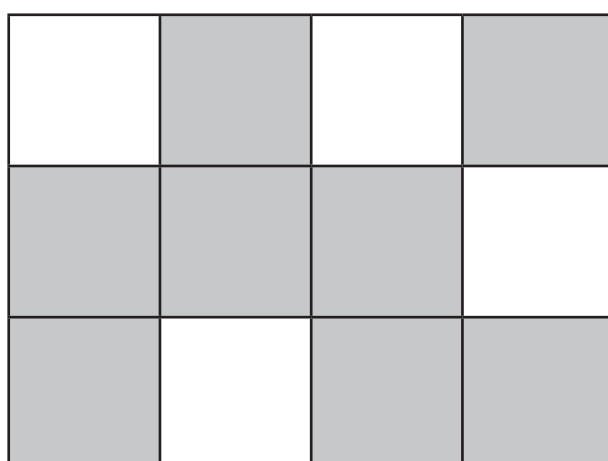
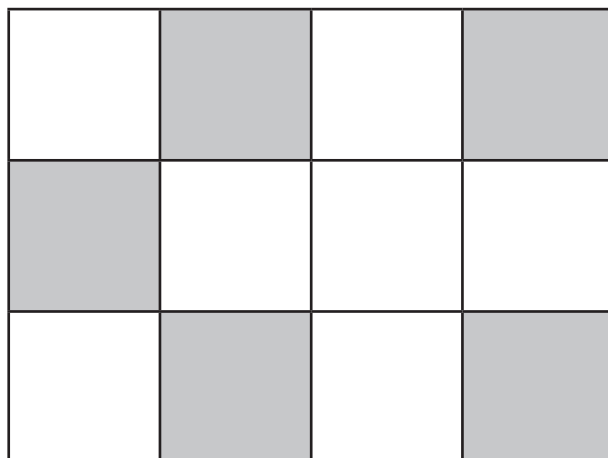

Приложение 17, занятие 7

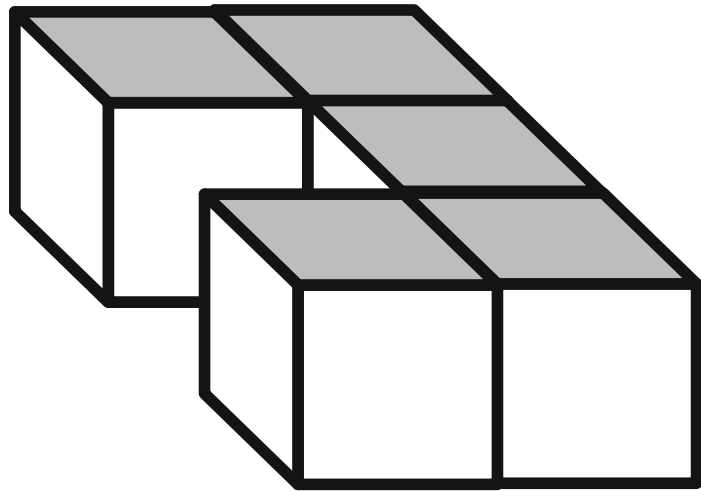

Г

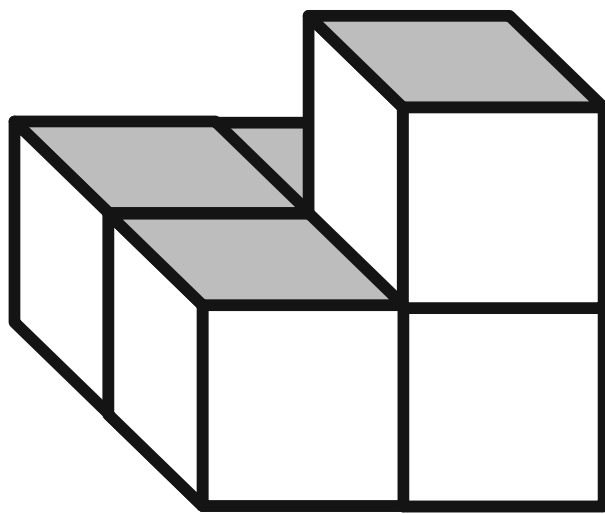

В

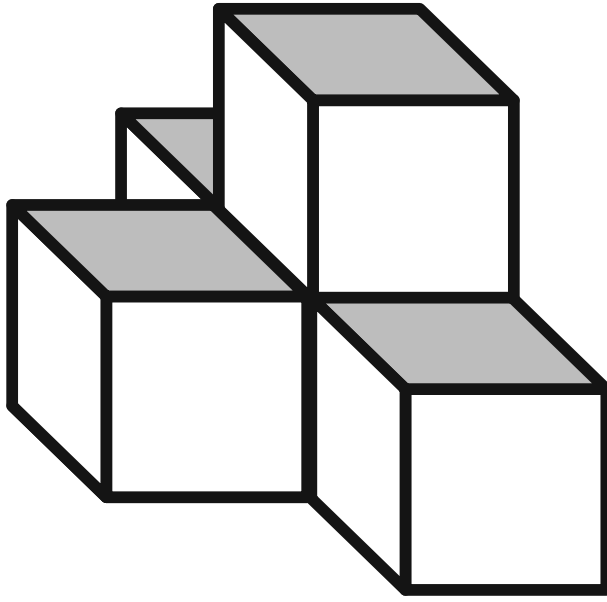

Д

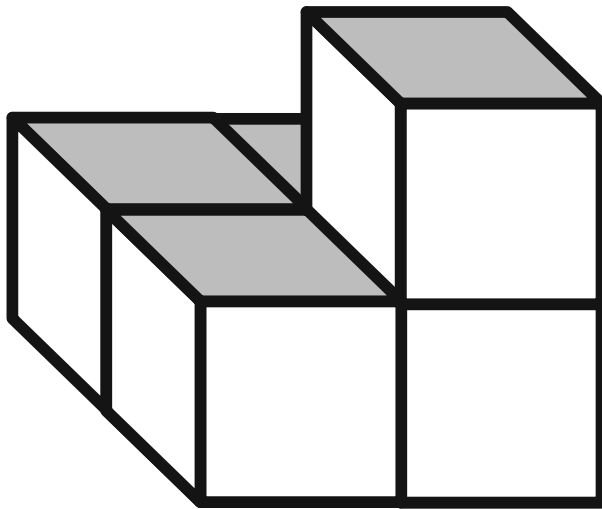

Г

Ф

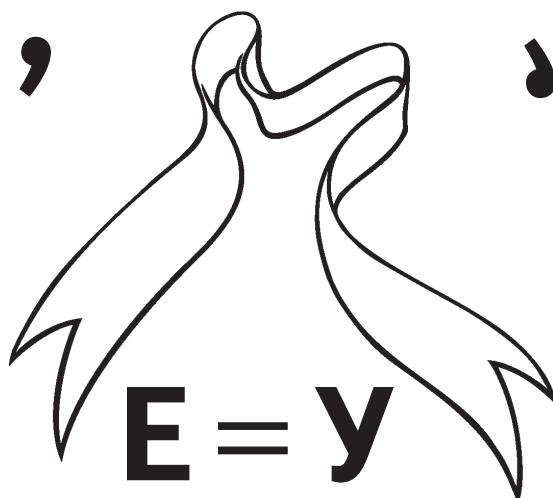

410 г

П



16 кг

Приложение 21, занятие 8

	а	б	в	г	д	е	ж	з	и	к
1										
2										
3										
4										
5										
6										
7										
8										
9										
10										

Деление «по разрядам»

Приложение 24, занятие 10

	+	=
	-	
:	.	

=		:
		+
.		-



=	.	-
:	.	+

.		=
	-	+
	:	=



Приложение 24, занятие 10

+		.
	=	
-		:

:		+
.	-	=
	-	



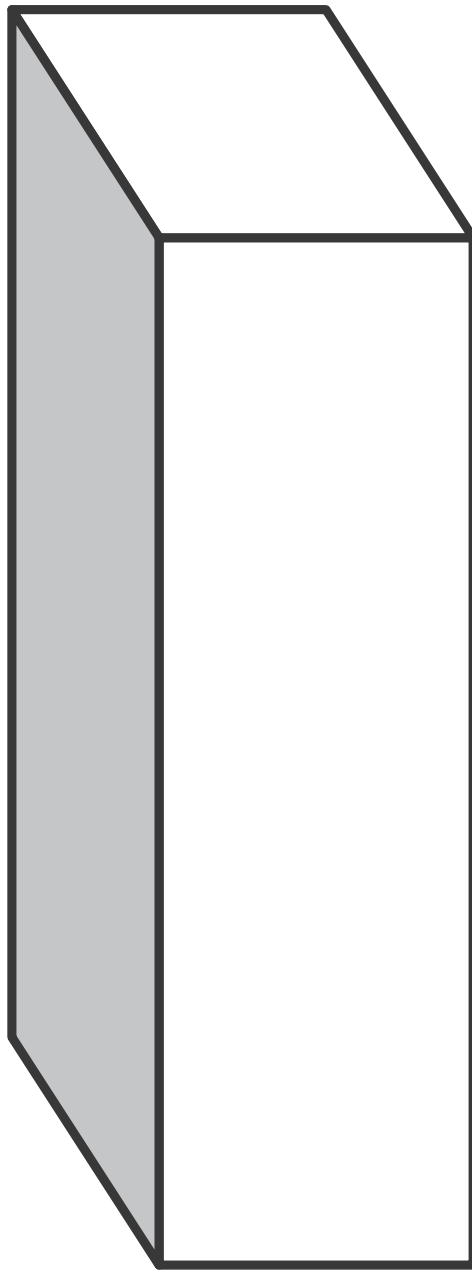

Приложение 26, занятие 12

$$39 : 3$$

$$56 : 4$$

$$72 : 24$$

$$84 : 4$$

Приложение 23, занятие 9

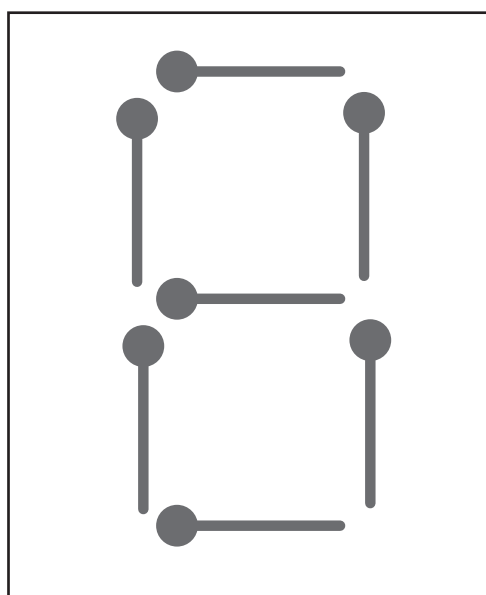
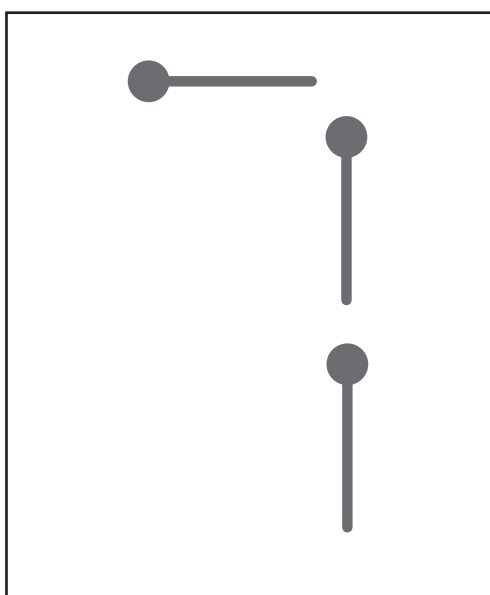
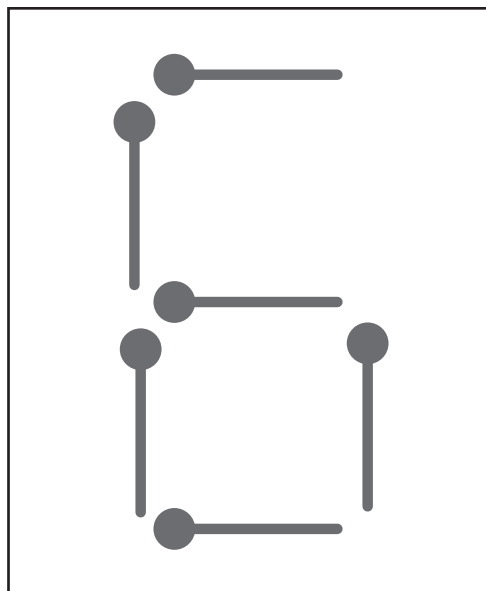
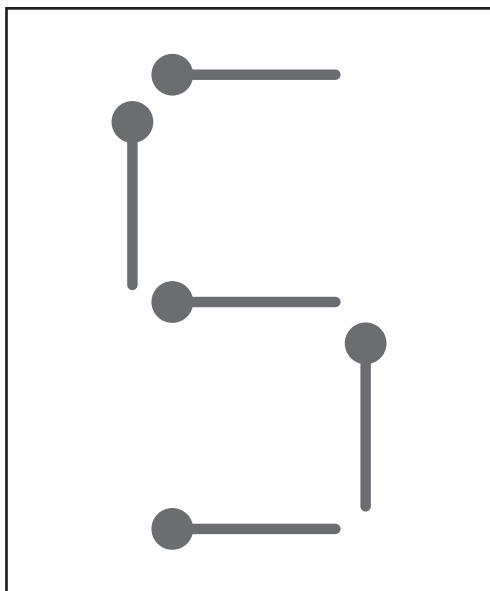

Приложение 27, занятие 12



0 : 10



5

:

5



0

Приложение 23, занятие 9

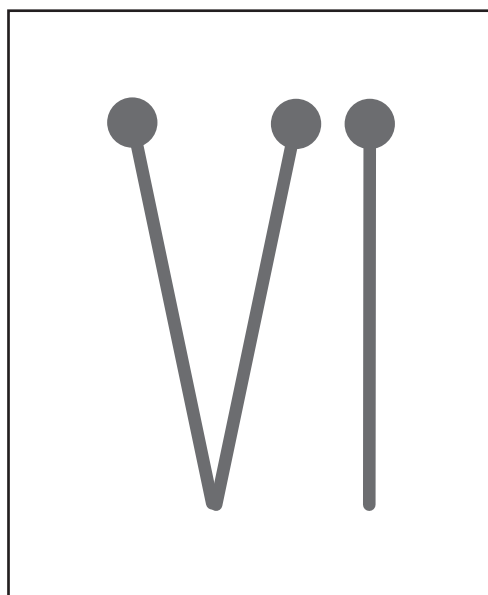
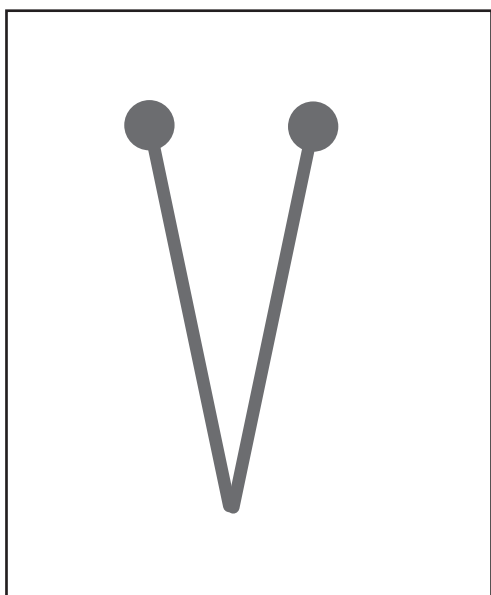
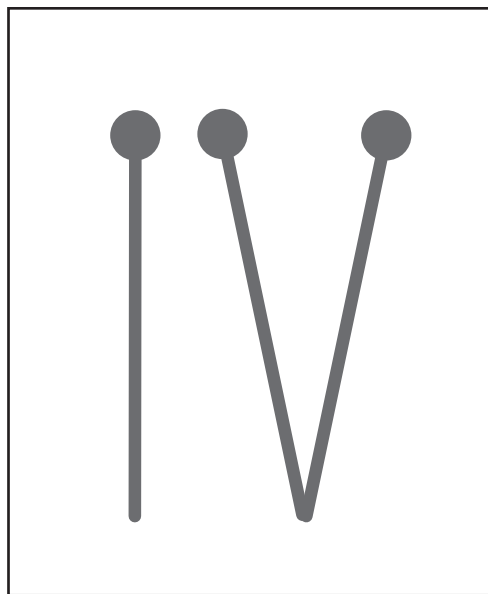
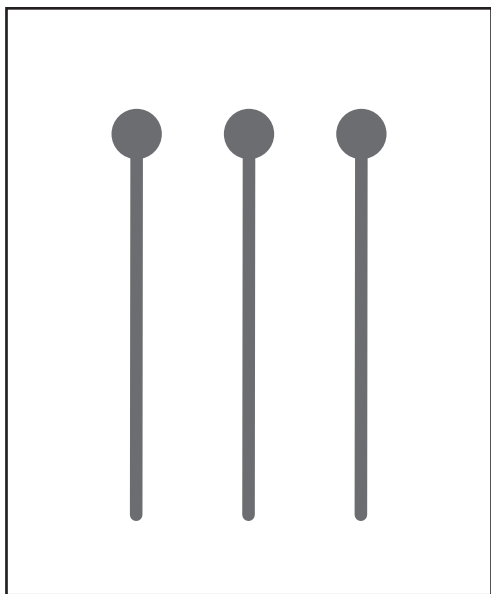

Приложение 28, занятие 12

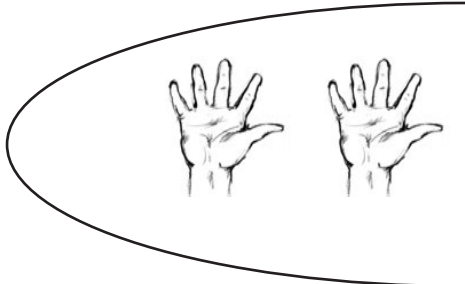

нет

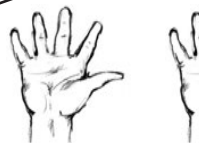

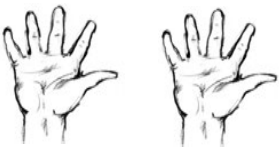
 ~~5~~

 • 2 + 1

От

Приложение 23, занятие 9

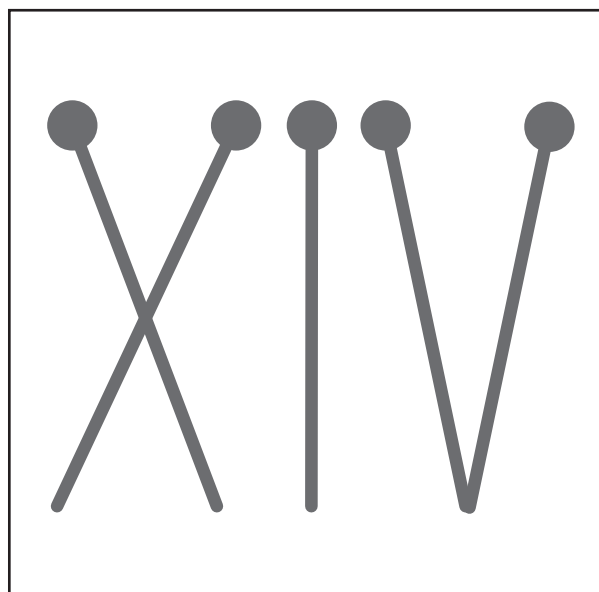
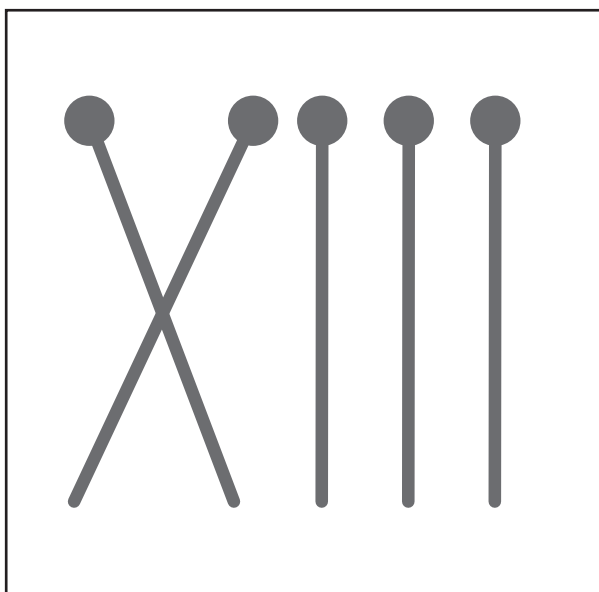
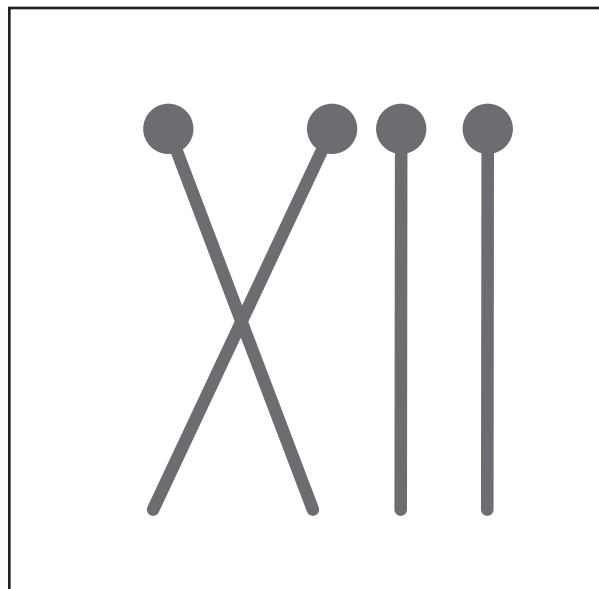
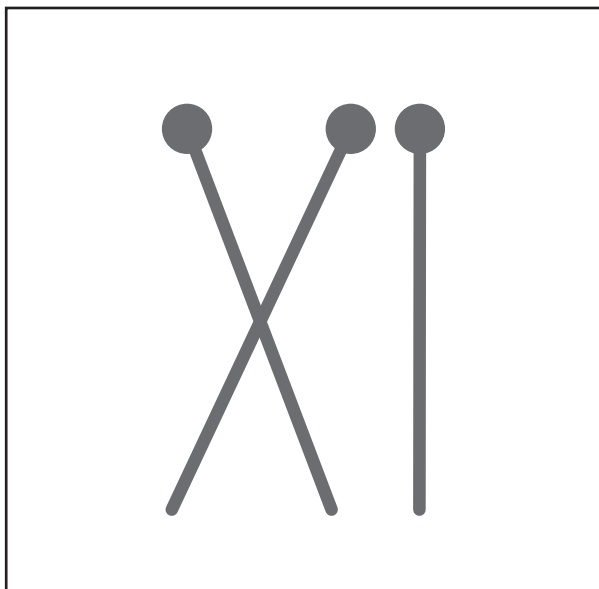

Приложение 35, занятие 20

ЦЕНА
КОЛИЧЕСТВО
СТОИМОСТЬ

Приложение 23, занятие 9

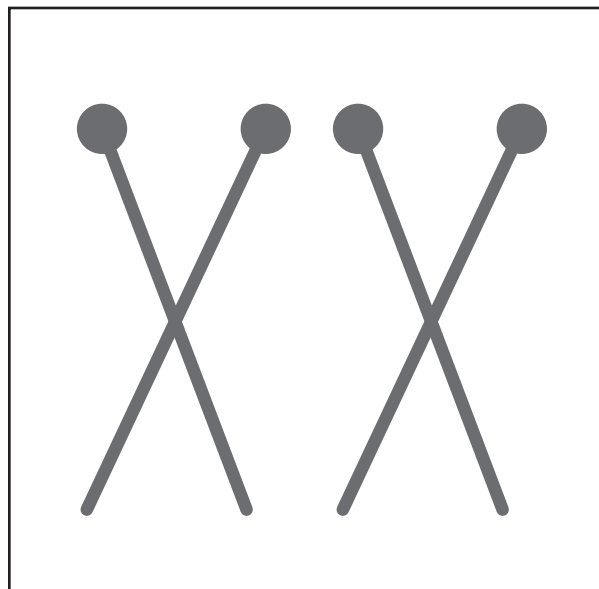
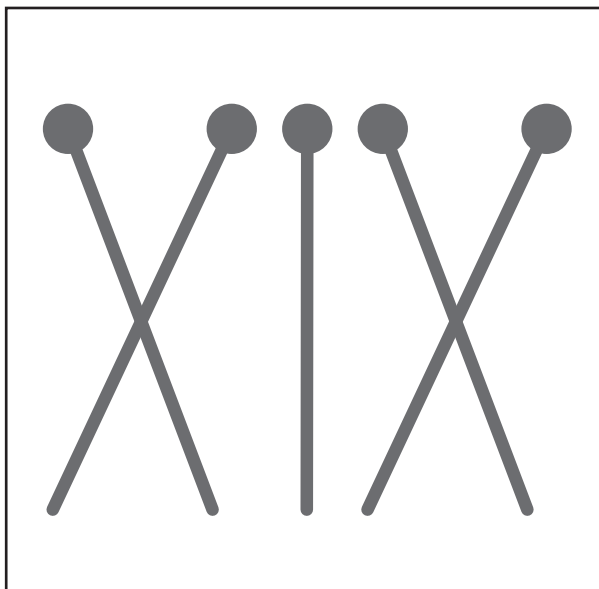

Приложение 31, занятие 17

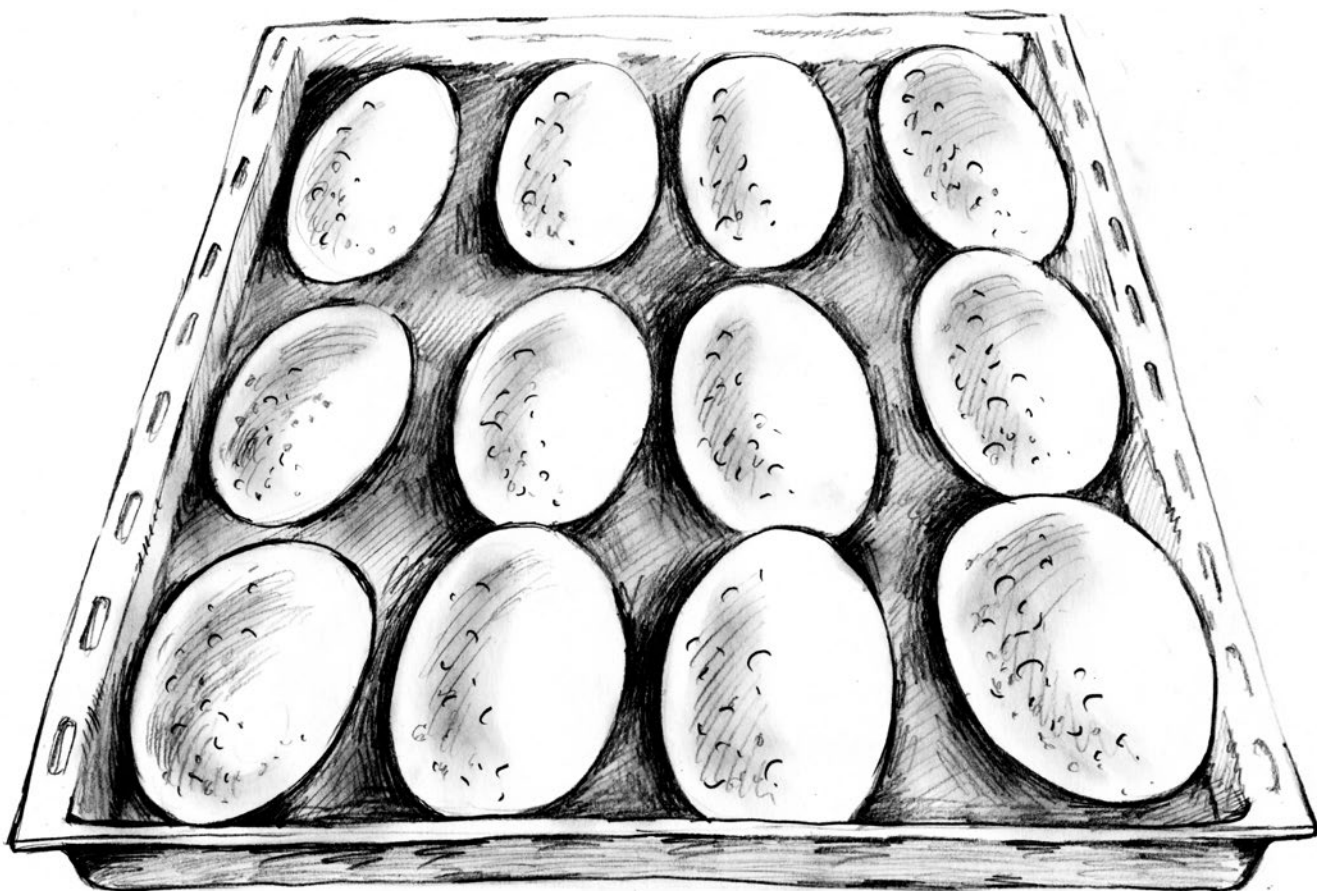

Предметов в одной группе
Групп
Всего предметов

Приложение 29, занятие 14

$$\text{а) } 945 : 9 = (900 + 40 + 5) : 9$$

$$\text{б) } 945 : 9 = (900 + 45) : 9$$

$$\text{в) } 216 : 6 = (180 + 36) : 6$$

$$\text{г) } 216 : 6 = (200 + 10 + 6) : 6$$

$$\text{д) } 483 : 7 = (400 + 80 + 3) : 7$$

$$\text{е) } 483 : 7 = (420 + 63) : 7$$

ЫЙ ЗЕЛЁНЫЙ

ЫЙ КРАСНЫЙ

ЁНЫЙ БЕЛЫЙ

ЫЙ ЗЕЛЁНЫЙ

ЫЙ КРАСНЫЙ

ЫЙ ЗЕЛЁНЫЙ

БОЛЬШЕЕ ЧИСЛО
МЕНЬШЕЕ ЧИСЛО
СУММА
РАЗНОСТЬ

?



10 книг

?



12 персиков



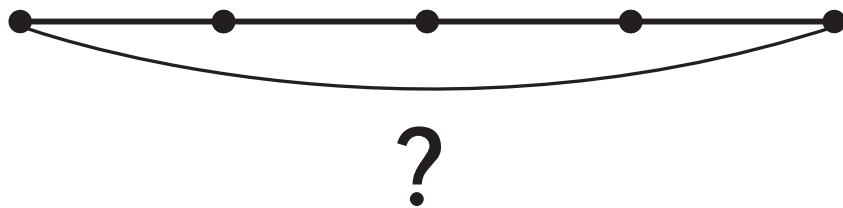
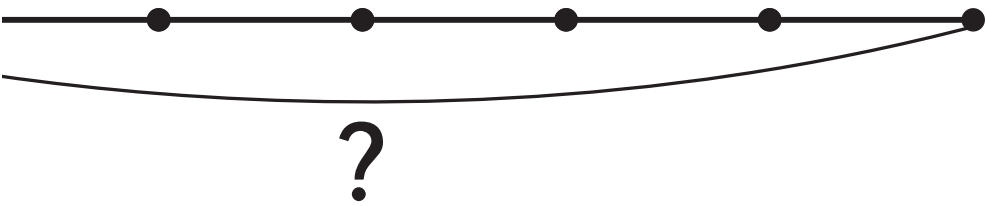

Приложение 42, занятие 24

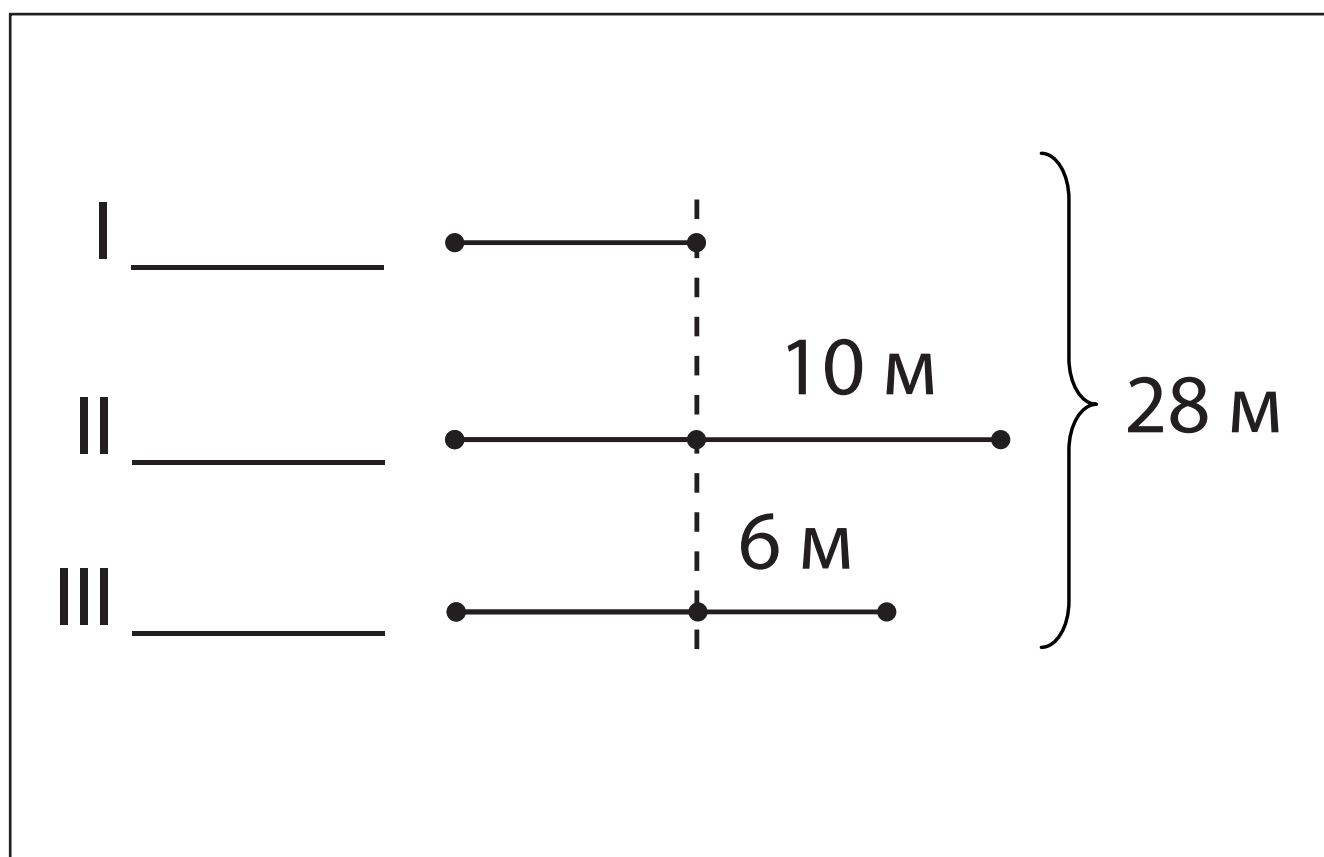
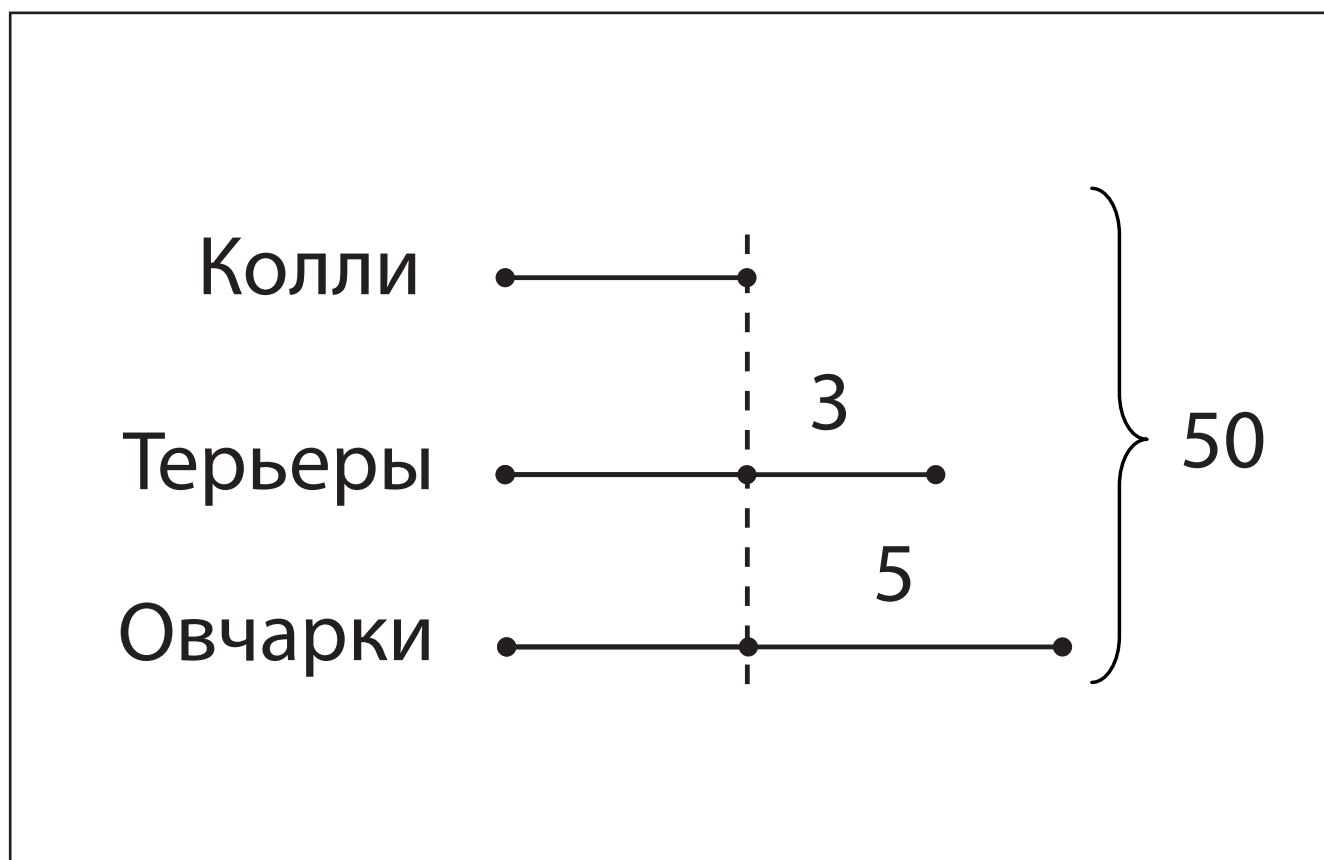

Приложение 43, занятие 25

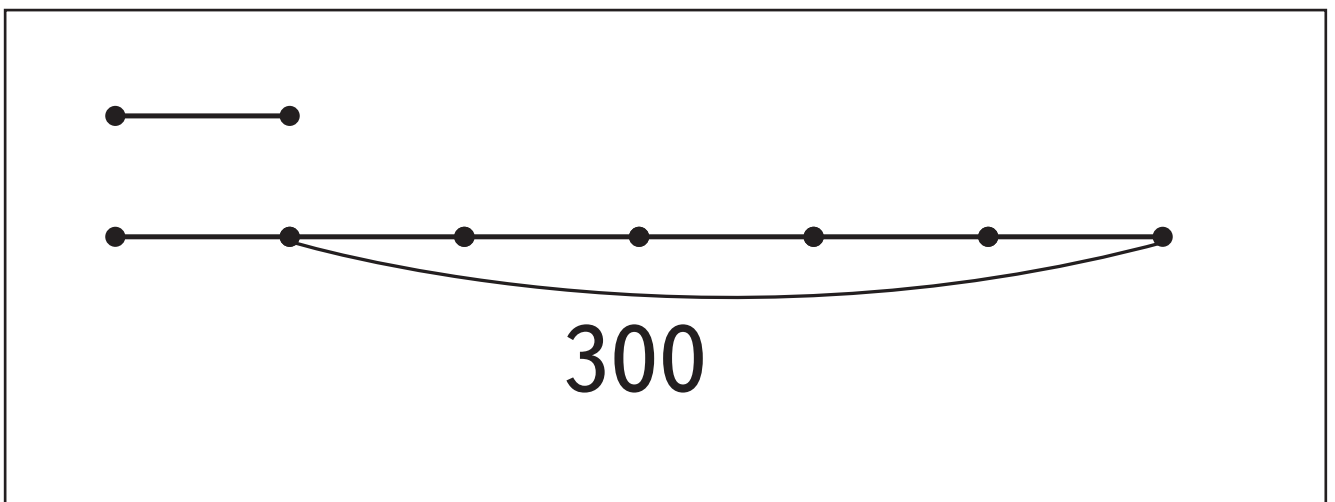
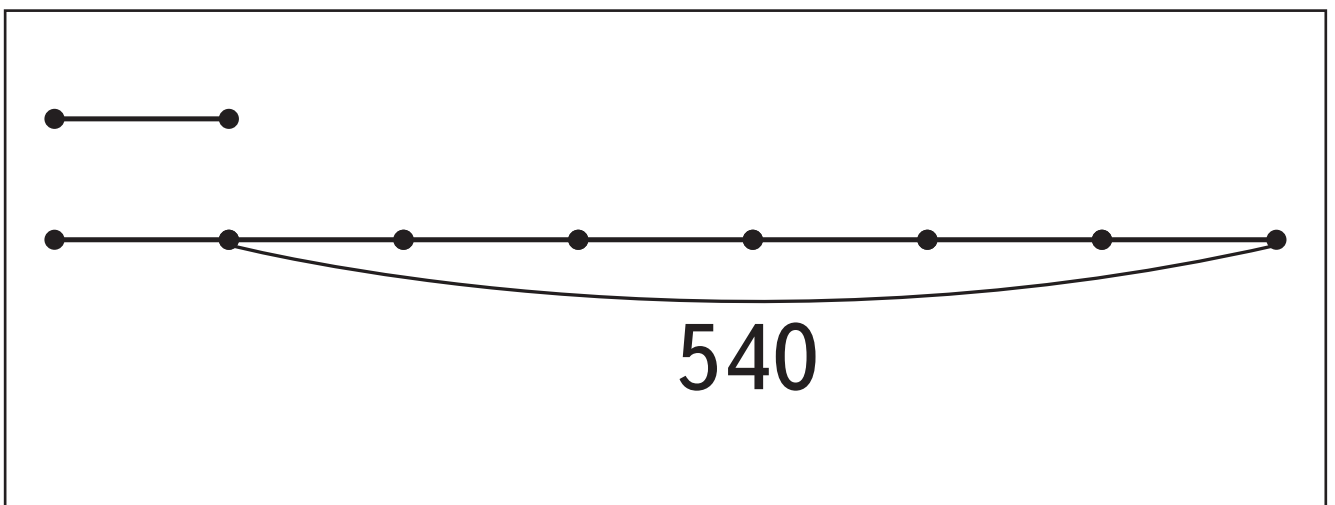
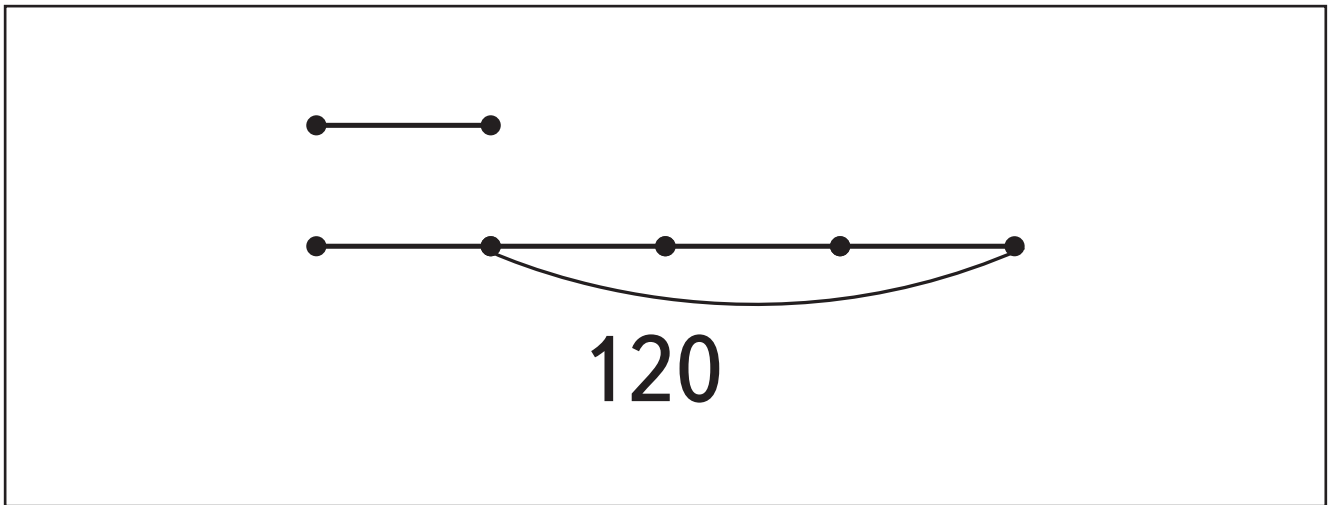

ВО + (72 + 28) + К

ГОСП + (1000 – 999)

ПО + (14 : 7) + Л

ВО + (92 – 85)

Р + (X – IX) + КА

АК + (X – VII) + СА

ОС + (24 : 8) + Ё

Приложение 50, занятие 32

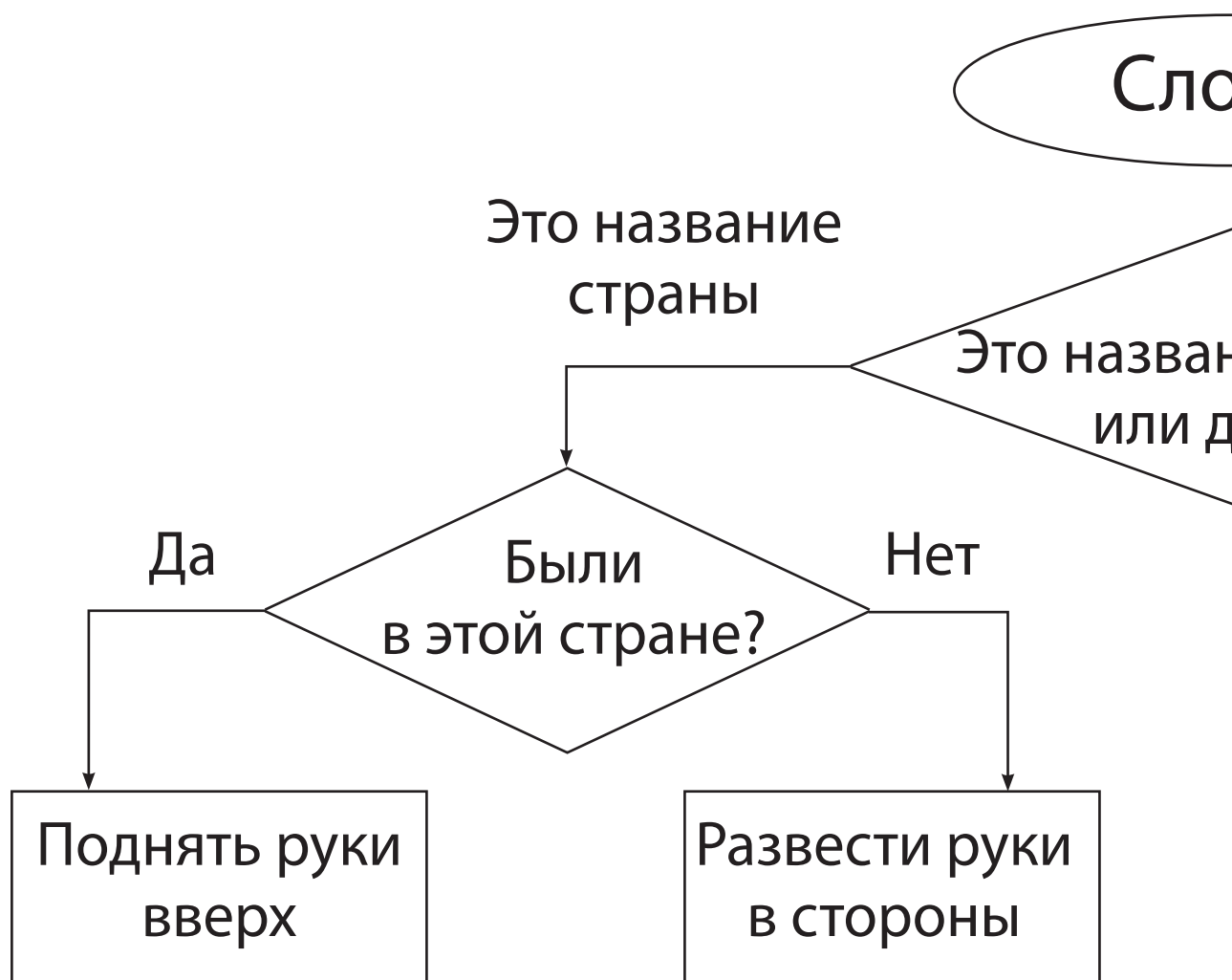

О + (2 · 2 + 1)

ВИ + (200 – 197) + НА

СМОР + (V – IV) + А

(5 · 3 + 25) + А

Ш + (4 · 6 : 8) + Х

ЭЛЕК + (XV – XII) + К

(1000 : 10) + ЙКА

Приложение 48, занятие 29

Задача 1. Сколько трёхцветных флажков можно нарисовать, используя четыре краски: синюю, красную, жёлтую, зелёную?

Решение

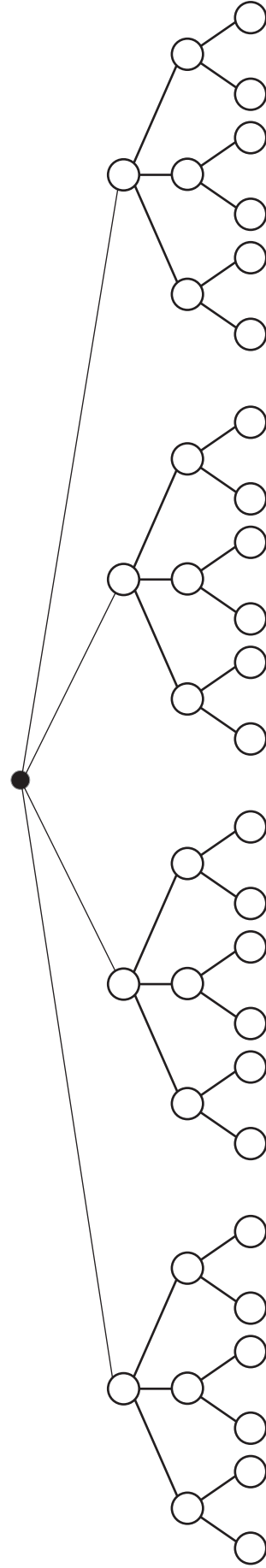

Ответ: _____ флажков.

Приложение 49, занятие 30

	Милана	Корней	Валя	Наум	Люся	Потап
Милана						
Корней						
Валя						
Наум						
Люся						
Потап						

Приложение 55, занятие 34

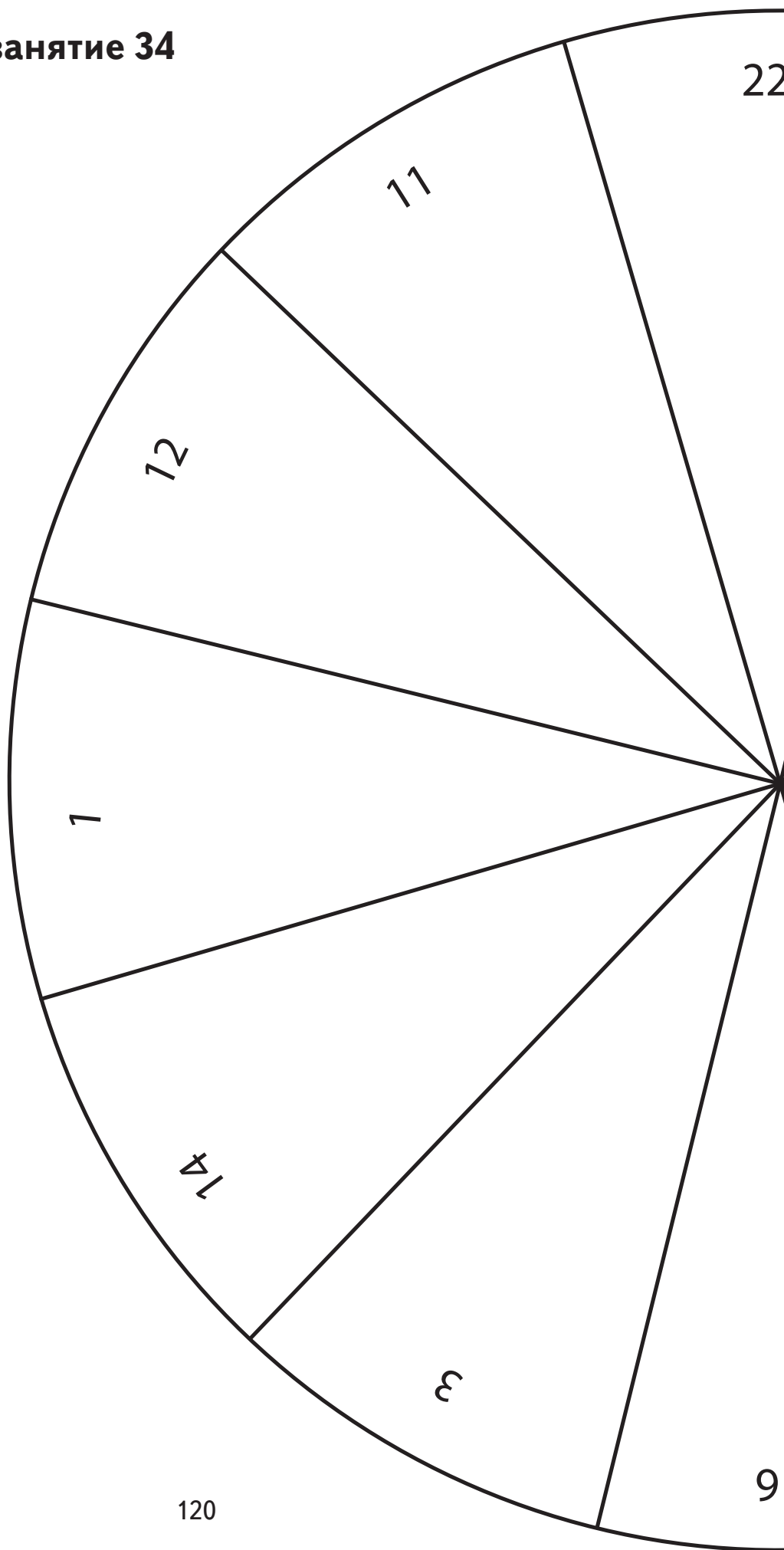

Приложение 56, занятие 34

77

39

42

47

280 886

448 202

741 561

257 291

Приложение 56, занятие 34

54

62

92

71

954 932

763 921

796 516

673 033

Приложение 55, занятие 34

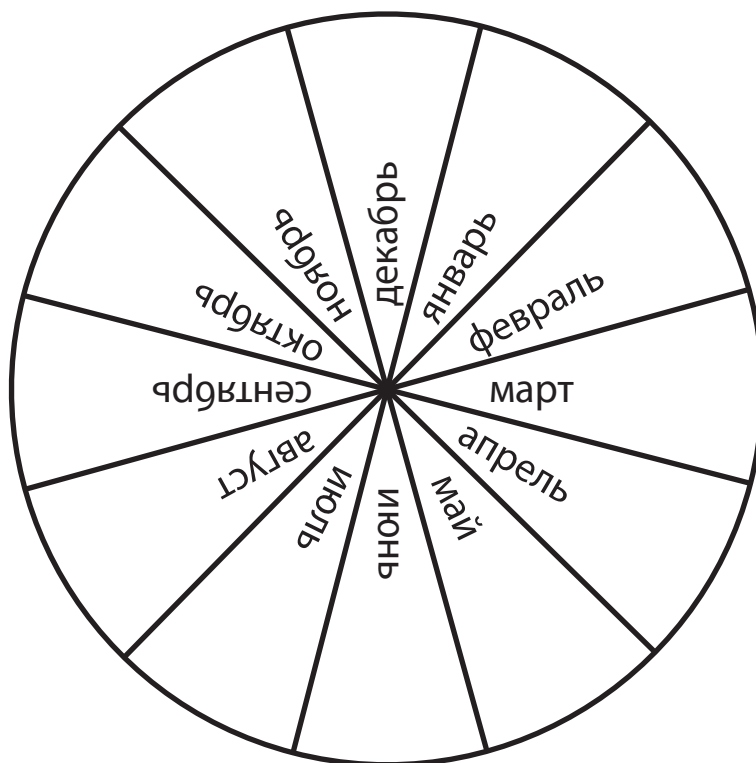

Приложение 52, занятие 32

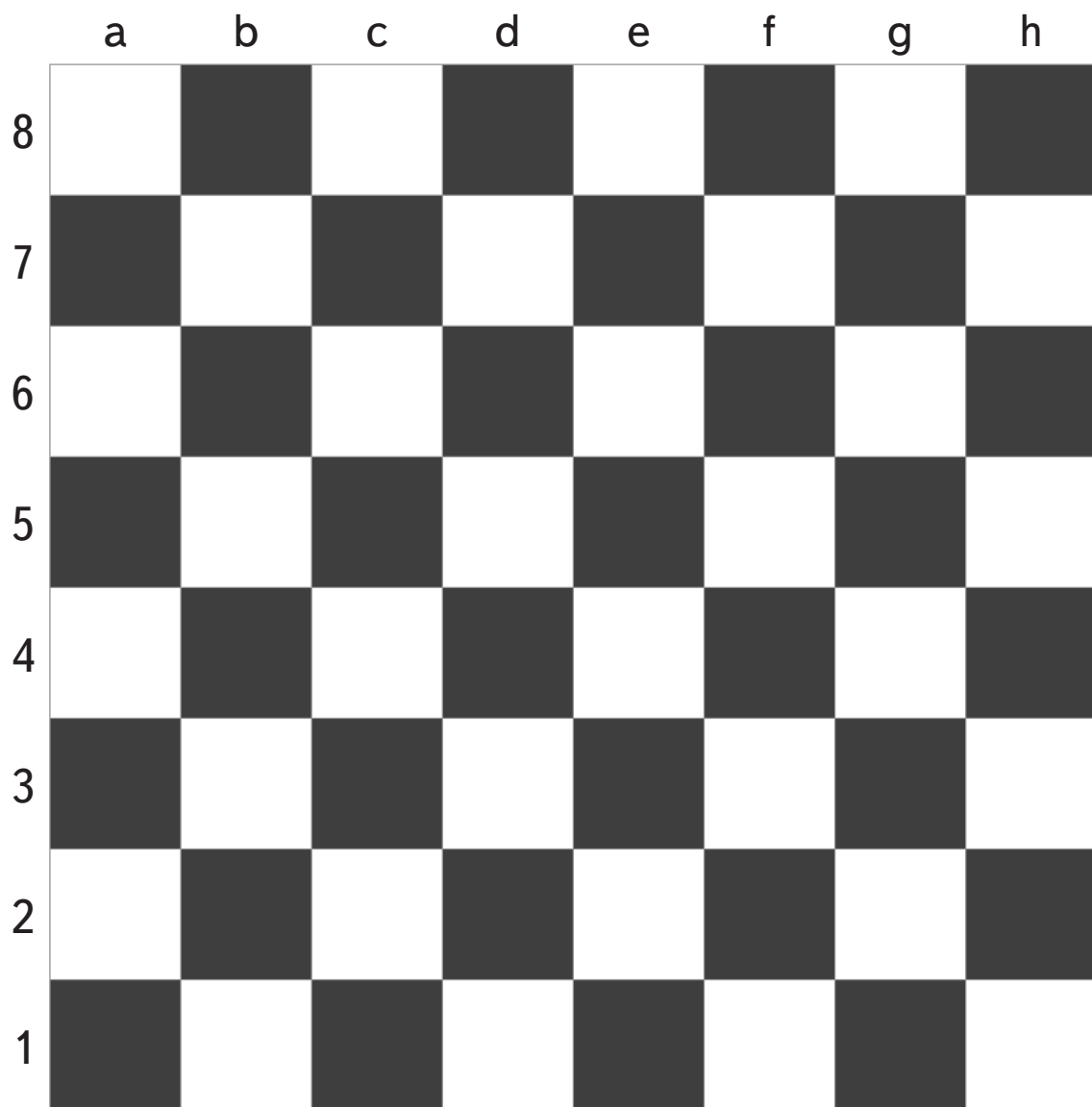

Приложение 58, занятие 35

